

Contents

Fundamentals

Chapter 1	Fundamentals of compressed air production.....	4
Chapter 2	Efficient compressed air treatment.....	6
Chapter 3	Why do we need to dry compressed air?.....	8
Chapter 4	Condensate: Correct drainage.....	10
Chapter 5	Condensate: Safe, economical treatment.....	12
Chapter 6	Efficient compressor control.....	14
Chapter 7	Optimised compressor performance to meet actual demand.....	18
Chapter 8	Energy savings with heat recovery.....	20
Chapter 9	Designing and installing a new compressed air distribution network.....	22
Chapter 10	Optimising an existing air distribution network.....	24
Chapter 11	Compressed air demand analysis (ADA) – Determining the current situation.....	26
Chapter 12	Determining the most efficient concept.....	30
Chapter 13	Efficient compressor station cooling.....	32
Chapter 14	Ensuring long-term reliability and cost-optimisation.....	34

Practical tips

Tip 1	Savings with optimised pressure.....	40
Tip 2	Correct pressure at the air connection.....	42
Tip 3	Efficient compressed air distribution.....	44
Tip 4	Pipework in the compressed air station.....	46
Tip 5	Correct compressor installation.....	48
Tip 6	Compressed air station ventilation (intake).....	49
Tip 7	Compressed air station ventilation (exhaust).....	50

Appendices

Appendix 1	Nomograph – Determining pipe diameter.....	50
Appendix 2	Questionnaire examples regarding the Energy Saving System Service.....	52

Foreword



Dipl.-Wirtsch.-Ing.
Thomas Kaeser



Dipl.-Wirtsch.-Ing.
Tina-Maria Vlantoussi-Kaeser

Dear reader,

More than two thousand years ago, Socrates, the famous Greek philosopher, succinctly said: “There is only one good, knowledge, and one evil, ignorance.”

These ancient words of wisdom from one of the founding fathers of Western civilisation apply today more than ever, since nothing seems more permanent than change. The ever-increasing scope and speed of change brought about by technological evolution and economic globalisation demand new answers and new strategies.

Now, more than ever, challenges should be seen as opportunities to achieve even greater success in the future – and should therefore be adopted and utilised to their full potential. Our increasingly networked and complex world is transforming knowledge into becoming the most valuable raw material of the future. Due to the exponential growth of this commodity, it is only those with a strong commitment to education and continued training who will reap the true rewards.

In the world of compressed air engineering, for example, merely having the knowledge of how to construct powerful compressors, and install and operate them correctly, is not enough – and hasn't been for some time.

Those who wish to take full advantage of what compressed air, as an energy carrier, has to offer must consider the entire compressed air system as a whole.

Moreover, they should have a detailed understanding of the numerous interactions and influences that occur within the system, as well as how it integrates into the operating environment.

KAESER KOMPRESSOREN is therefore dedicated to the further training of its customers and achieves this in a number of ways. For example, qualified technical experts with extensive practical experience travel around the world every year, making stops on every continent to speak at conferences, information events and seminars about efficient compressed air production and usage. Of course, this is in addition to the many technical publications across a broad range of media.

In this brochure you'll find an executive summary of our experts' extensive knowledge. Following an in-depth yet highly accessible introduction to the field of compressed air technology, you'll find a series of practical tips for system operators and compressed air users. You will also recognise a common theme throughout: in so many cases and in so many different ways, even small changes in the compressed air system result in significant and tangible improvements in the efficiency and availability of this key energy carrier.

Fundamentals of compressed air production

It's the same with compressed air as with many other things in life: a small cause can have a large effect – both in a positive and negative sense. Upon closer inspection things are often different from how they at first appear. In unfavourable conditions compressed air can be expensive, but in the right circumstances it is very economical. In this first chapter we will explain the terms used in compressed air engineering and the things you should watch for in connection with them.

$$V_1 = \frac{V_2 \times P_2 \times T_1}{[p_1 - (p_D \times F_{rel})] \times T_2}$$

The result is the free air delivery (FAD) of the compressor package. This figure is not to be confused with the airend delivery (block delivery).

Note: DIN 1945 and ISO 1217 alone only define the airend delivery.

1. Free air delivery

The air delivery of a compressor (known also as the free air delivery or FAD) is the expanded volume of air it forces into the air main (network) over a given period of time. The correct method of measuring this volume is given in the following standards: DIN 1945, Part 1, **Annex F** and ISO 1217, **Annex C**. The measurement process is performed as follows as shown in Fig. 1: the temperature, atmospheric pressure and humidity must first be measured at the air inlet of the compressor package. Then, the maximum working pressure, temperature and volume of compressed air discharged from the compressor are measured. Finally, the volume V_2 measured at the compressor outlet is referred back to the inlet conditions using the shown equation (see formula).

2. Motor shaft power

The motor shaft power is the power that the motor delivers mechanically to its output shaft. The optimal value for motor shaft power is the point at which optimum electrical energy efficiency is achieved and the $\cos \phi$ power factor is reached without the motor overloading. This figure lies within the range of the rated motor power. The rated power is shown on the motor's nameplate.

Note: If the motor shaft power deviates too far from the rated motor power, the compressor will run inefficiently and/or will be subject to increased wear.

3. Electrical power consumption

The electric power consumption is the power that the drive motor draws from the mains power supply with a defined mechanical load on its shaft (motor

shaft power). The power consumption exceeds the motor shaft power by the value of the motor losses – both electrical and mechanical – from bearings, fan, etc. The ideal electric power consumption P can be calculated using the formula:

$$P = U_n \times I_n \times \sqrt{3} \times \cos \phi_n$$

U_n , I_n , and $\cos \phi_n$ are quoted on the motor nameplate.

4. Specific power

The specific power of a compressor (Fig. 2) is the relationship between the electric power consumed and the compressed air delivered at a given working pressure. The electrical power consumption is the sum of the power consumed by all consumers in a compressor, for example, drive motor, fan, oil pump, auxiliary heating, etc.

If the specific power is needed for an economic appraisal, it should refer to the compressor package as a whole and the maximum working pressure. The overall electrical power consumption at maximum pressure is then divided by the FAD at maximum pressure:

$$P_{spec.} = \frac{\text{Electrical power consumption}}{\text{Delivery}}$$

5. IE – The new formula for energy-saving drives

Efforts in the USA to reduce the energy requirements of three-phase asynchronous motors resulted in the Energy Policy Act (EPACT) becoming law in 1997. A short while later, an efficiency classification system was also introduced in Europe. The international IEC standard for electric motors has been in place since 2010. Classifications and legal requirements subsequently

resulted in significantly improved energy efficiency for premium class electrical motors. High efficiency motors provide significant advantages:

a) Lower operating temperatures

The internal efficiency loss caused by heat generation and friction can be as high as 20 percent in small motors and 4-5 percent in motors upward of 160kW. IE3/IE4 motors operate with significantly less heating and, as a result, with much lower losses (Fig. 3): A conventional motor with F class insulation operates at about 80K, giving it a temperature reserve of 20K, whereas an IE motor, working under the same operating conditions, will run at only about 65K, increasing its reserve to 40K.

b) Longer life

Lower working temperatures mean less thermal stress on the motor, the motor bearings and terminals. Motor service life is significantly extended as a result.

c) Six percent more compressed air for less power consumption

Less heat loss leads to increased efficiency. Thus, with precise matching of the compressors to the enhanced efficiency motors, KAESER is able to achieve up to a six percent increase in air delivery and a five percent improvement in specific power. This means improved performance, shorter compressor running time and less power consumed per cubic metre of compressed air delivered.

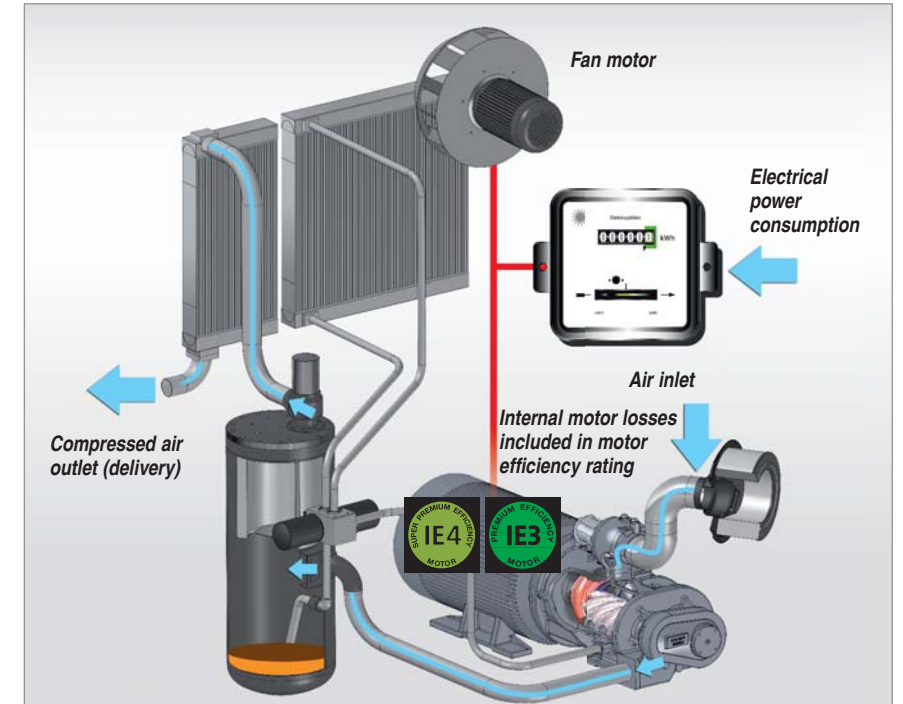

Fig. 2: Basic layout of a rotary screw compressor; determining specific power

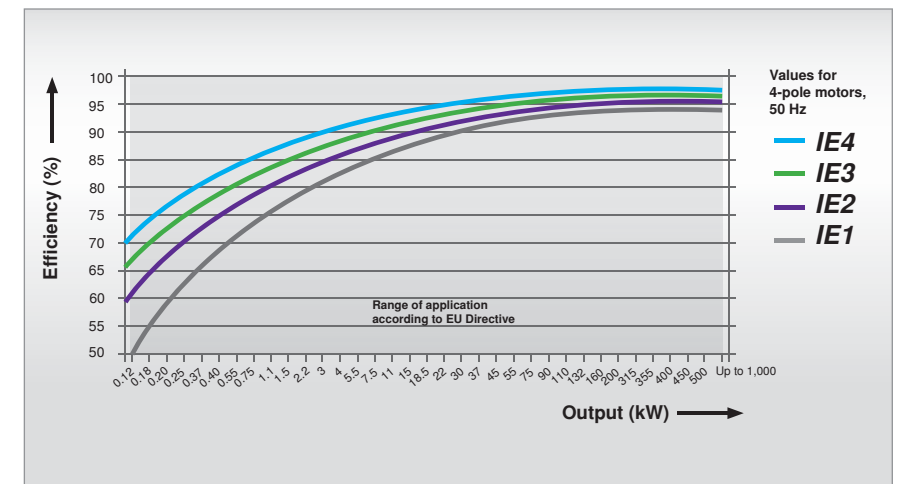

Fig. 3: The IEC standard – the new efficiency classification of electric motors. Beginning with 1 January 2015, IE3 motors are mandatory in the EU. Meanwhile, a further improved motor efficiency class IE 4 has been defined.

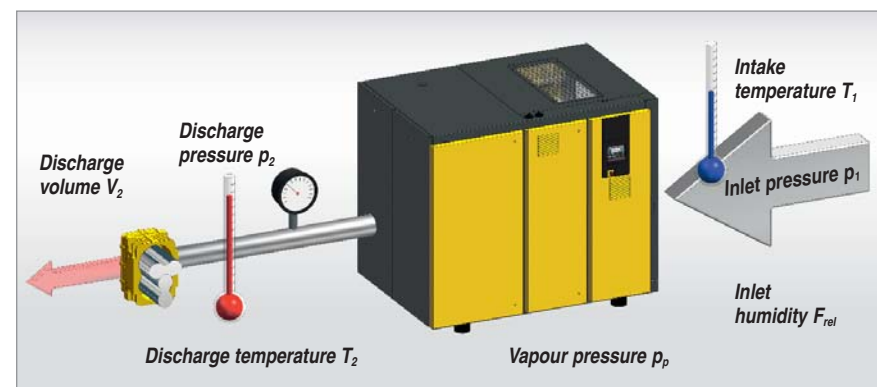

Fig. 1: Free air delivery as per ISO 1217, Appendix C (DIN 1945, Appendix F)

Efficient compressed air treatment

So, which compressor system provides the most cost-effective way of producing oil-free compressed air? Leaving aside the claims of individual manufacturers, there is no doubt that premium quality, oil-free compressed air can be achieved both with dry-running and fluid-cooled compressors. Ideally therefore, the deciding factor to consider when selecting an air system should be efficiency.

1. What does “oil-free compressed air” mean?

According to ISO 8573-1, compressed air can be described as oil-free if its oil content (including oil vapour) is less than 0.01 mg/m³. That is approximately four-hundredths of that contained in normal atmospheric air. This amount is so minute as to be barely measurable. But what about the quality of the compressor’s intake air?

Of course, this depends greatly on local ambient conditions. Even in normally contaminated zones, the hydrocarbons in the air caused by industry and traffic emissions can lie between 4 and 14 mg/m³. In industrial areas, where oil is used as a lubricating, cooling and processing medium, the mineral oil content can be far in excess of 10 mg/m³.

Other impurities such as hydrocarbons, sulphur dioxide, soot, metals and dust are also present.

2. Why treat air?

Every compressor, regardless of type, draws in contaminated air, concentrates the contamination by compression and, if no measures are taken to remove it, passes it on to the compressed air network.

a) “Oil-free” compressors

This especially applies to so-called “dry-running”, or “oil-free” compressors. Because of the pollution mentioned

above, it is impossible to produce oil-free compressed air with a compressor that is equipped only with a three-micron dust filter. Other than these dust filters, so-called “oil-free” compressors have no further treatment components.

b) Fluid- or oil-cooled compressors

In contrast, aggressive matter is neutralised and solid particles are partly washed out of the air by the cooling fluid (oil) in fluid-cooled rotary compressors.

3. Non-defined compressed air quality without treatment

Despite the higher degree of achieved compressed air purity, the same applies here too: It’s a no-go without compressed air treatment. With “dry” or oil-cooled compression alone, under normal intake conditions and with the associated air contaminant levels, it is not possible to achieve defined oil-free compressed air quality in accordance with ISO 8573-1.

As to how efficient compressed air production is, depends on the pressure and delivery range, as well as on the required compressor type. Sufficient drying forms the foundation for all application-tailored compressed air treatment. Energy-saving refrigeration drying is usually the most efficient method (also see Chapter 3, pg. 9).

4. Treatment with the KAESER Pure Air System

Modern fluid-/oil-cooled rotary screw compressors are approximately 10% more efficient than “dry-running”, or “oil-free”, compressor models. The Pure Air System, developed by KAESER for fluid-/oil-cooled rotary screw compressors, and for dry-running compressors, provides further cost-savings of up to 30%. The residual compressed air oil content achieved by this system is less than 0.003 mg/m³ and is therefore far below the limit for Quality Class 1 (regarding residual oil content) stipu-

lated in the ISO standard. The system includes all the treatment components needed for achieving the required air quality. Depending on the application, either refrigeration or desiccant dryers (also see Chapter 3, pg. 9) are used together with various filter combinations. Air qualities ranging from simple dry air through to particle- and oil-free air to sterile air are reliably and cost-effectively achieved in accordance with the quality classes set out in the ISO standard (Fig. 1).

Choose the required grade of treatment according to your field of application:

Examples: Selection of treatment classes to ISO 8573-1 (2010)

Air treatment with refrigeration dryer

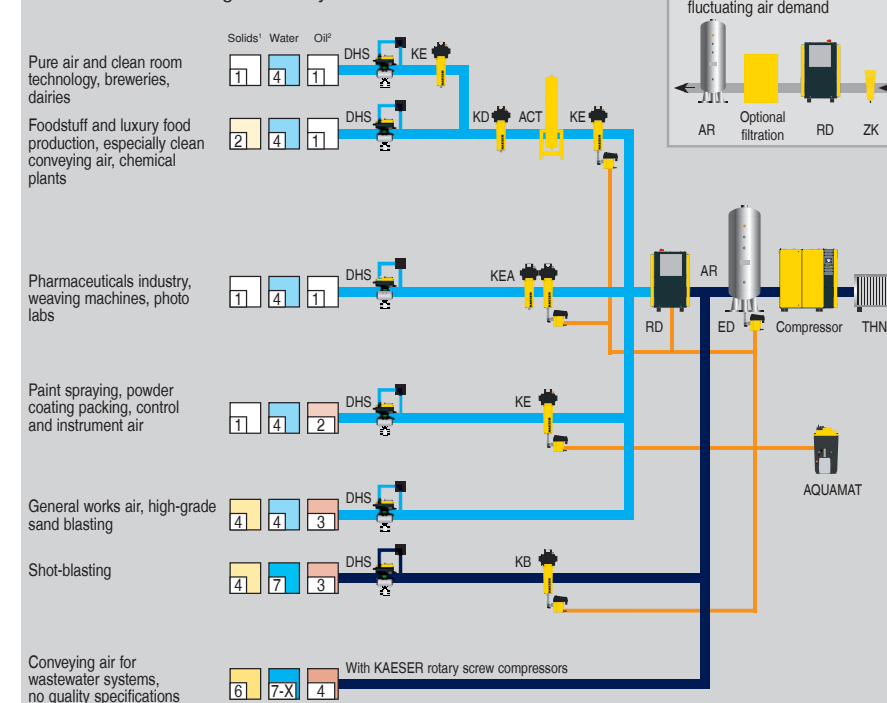

Compressed air treatment with desiccant dryer

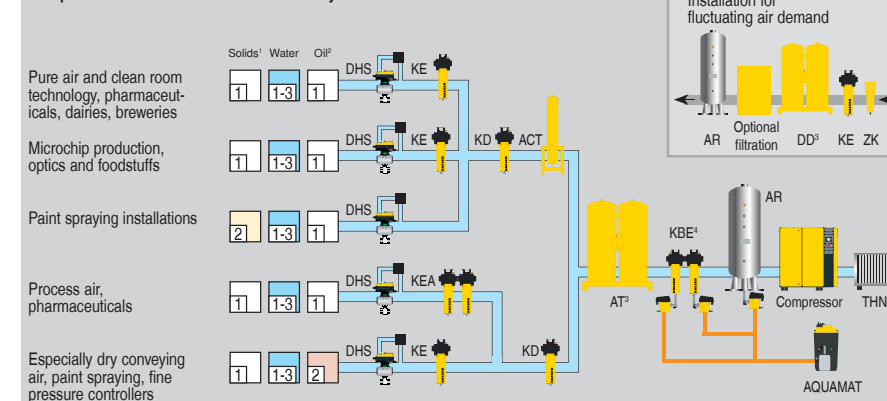

¹⁾ Achievable particle class with expert-implemented pipework and commissioning.
²⁾ Achievable total oil content with use of recommended compressor oils and unloaded intake air.
³⁾ High temperature filters and possibly an aftercooler are required downstream from heat-regenerated desiccant dryers.
⁴⁾ The use of an ‘Extra Combination’ (a filter combination comprising a KB and downstream KE filter) is recommended for critical applications requiring exceptionally high compressed air purity (e.g. in the electronics and optics sectors).

Explanation	
ACT	Activated carbon adsorber
AQUAMAT	AQUAMAT
DD	Desiccant dryer
DHS	Air-main charging system
AR	Air receiver
ED	ECO-DRAIN
KA	Activated carbon filter, adsorption
KB	Coalescence filter, Basic
KBE	Extra Combination
KD	Particulate filter, dust
KE	Coalescence filter, Extra
KEA	Carbon Combination
RD	Refrigeration dryer
THNF	Bag filter
ZK	Centrifugal separator

Compressed air quality classes to ISO 8573-1(2010):

Solid particles / dust			
Class	Max. particle count per m ³ * of a particle size d in [µm]		
	0.1 ≤ d ≤ 0.5	0.5 ≤ d ≤ 1.0	1.0 ≤ d ≤ 5.0
0	Please consult KAESER regarding specific requirements		
1	≤ 20,000	≤ 400	≤ 10
2	≤ 400,000	≤ 6,000	≤ 100
3	Not defined	≤ 90,000	≤ 1,000
4	Not defined	Not defined	≤ 10,000
5	Not defined	Not defined	≤ 100,000
Particle concentration C _p in mg/m ³ *			
6	0 < C _p ≤ 5		
7	5 < C _p ≤ 10		
X	C _p > 10		

Water	
Class	Pressure dew point, in °C
0	Please consult KAESER regarding specific requirements
1	≤ -70 °C
2	≤ -40 °C
3	≤ -20 °C
4	≤ +3 °C
5	≤ +7 °C
6	≤ +10 °C
Concentration of liquid water C _w in g/m ³ *	
7	C _w ≤ 0.5
8	0.5 < C _w ≤ 5
9	5 < C _w ≤ 10
X	C _w > 10

Oil	
Class	Total oil concentration (fluid, aerosol + gaseous) mg/m ³ *
0	Please consult KAESER regarding specific requirements
1	≤ 0.01
2	≤ 0.1
3	≤ 1.0
4	≤ 5.0
X	> 5.0

*) With reference conditions 20 °C, 1 bar(a), 0%

Fig. 1: An air treatment chart, such as the one shown above, is included in every KAESER rotary screw compressor brochure. The correct combination of treatment equipment for any application can be easily determined at a glance.

Why do we need to dry compressed air?

The problem is in the air – quite literally: When atmospheric air cools down, as is the case after compression in a compressor, water vapour precipitates as condensate. Under reference conditions (+20 °C ambient temperature, 70% relative humidity and 1 bar_{abs}), a compressor with a free air delivery of 5 m³/min will “produce” approximately 30 litres of condensate per eight hour shift. This condensate has to be removed from the air system in order to prevent potential damage and avoid costly production downtime. Cost-effective and environmentally-friendly compressed air drying is therefore a key component of application-tailored compressed air treatment.

1. A practical example

If a fluid- / oil-cooled rotary screw compressor draws in 10 m³ of air per minute at 20 °C at atmospheric pressure and with a relative humidity of 60%, this air will contain approximately 100g of water vapour. If this air is compressed to an absolute pressure of 10 bar at a compression ratio of 1:10, then this is referred to as 1 working cubic metre. However, at a temperature of 80 °C after compression, the air is capable of absorbing up to 290 g of water per cubic metre. As only approx. 100g is available, the air is very dry with a relative humidity of approximately 35%, so that no condensate can form. The temperature of the air is then reduced from

80 to approx. 30 °C in the compressor's aftercooler.

At this temperature, a cubic metre of air can absorb only about 30g of water. As a result, an excess of approx. 70g/min occurs, which condenses and is then separated. This means that approximately 35 litres of condensate accumulate during an eight hour working shift. A further 6 litres are separated each shift if using a downstream refrigeration dryer. The air is initially cooled down to +3 °C in these dryers and is then later rewarmed to ambient temperature. This leads to a water vapour saturation deficit of approximately 20% and therefore to drier, better quality compressed air (Fig. 1).

2. Causes of humidity

Our ambient air always, to a lesser or greater extent, contains a certain amount of water. The actual amount of moisture depends on the temperature of the air. For example, air saturated to 100% with water vapour at a temperature of +25 °C holds almost 23g of water per cubic metre.

3. Accumulation of condensate

Condensate forms if the volume of the air is reduced and the temperature of the air is reduced at the same time. Therefore, the capacity of the air to

absorb water is reduced. This is precisely what happens in the aird and in the aftercooler of a compressor.

4. Important terms – A brief explanation

a) Absolute air humidity

Absolute air humidity is the water content of the air, given in g/m³.

b) Relative air humidity (H_{rel})

Relative air humidity is the ratio of the current absolute humidity to the highest possible absolute humidity, or saturation point (100% H_{rel}). This is variable according to temperature; warm air can hold more water vapour than cold air.

c) Atmospheric dew point

The atmospheric dew point is the temperature at which the air reaches 100% humidity saturation (H_{rel}) at atmospheric pressure (ambient conditions).

d) Pressure dew point

The pressure dew point (PDP) is the temperature at which compressed air reaches its humidity saturation point (100% H_{rel}) under its absolute pressure. This means, in the above case, that air subjected to a pressure of 10bar (a) with a pressure dew point of +3 °C has an absolute humidity of 6g per working cubic metre. To clarify – if the cubic metre mentioned is expanded from 10bar (a) to atmospheric pres-



Fig. 1: Condensate occurs as a result of compressed air production, storage and treatment (figures based on 10 m³/min, 10 bar_{abs}, 8 h, 60% H_{rel} and 20 °C)

sure then its volume multiplies by 10 times. The water vapour component of 6g remains unchanged, but is now distributed over 10 times the volume. This means that every cubic metre of free air now contains only 0.6g of water vapour, which corresponds to an atmospheric dew point of -24 °C.

5. Efficient and environmentally-friendly compressed air drying with a refrigeration or desiccant dryer?

New environmental legislation concerning refrigerants cannot change the fact that desiccant dryers do not provide an alternative to refrigeration dryers, neither from an economical nor from an environmental point of view. Refrigeration dryers consume only 3% of the power that the compressor needs to produce the compressed air; desiccant dryers, on the other hand, require 10 to 25 percent, or more. For this reason, refrigeration dryers should always be used wherever possible.

Drying process	Pressure point °C	Typical specific power-requirement kW / m ³ /min **)
Refrigeration dryer	+ 3	0.1
HYBRITEC	+ 3 / - 40 *)	0.2 0.3
Heat-regenerated desiccant dryer	- 40	0.5 - 0.6
Heatless-regenerated desiccant dryer	- 20 - 70	1.4 - 1.6

Fig. 2: Different drying processes are available depending on the required pressure dew point

The use of a desiccant dryer only makes sense if an extremely dry air quality with a pressure dew point down to -20, -40 or -70 °C is required (Fig. 2). Over the course of a working day, compressed air systems often experience considerable fluctuations in compressed air demand. Similar also occurs over the

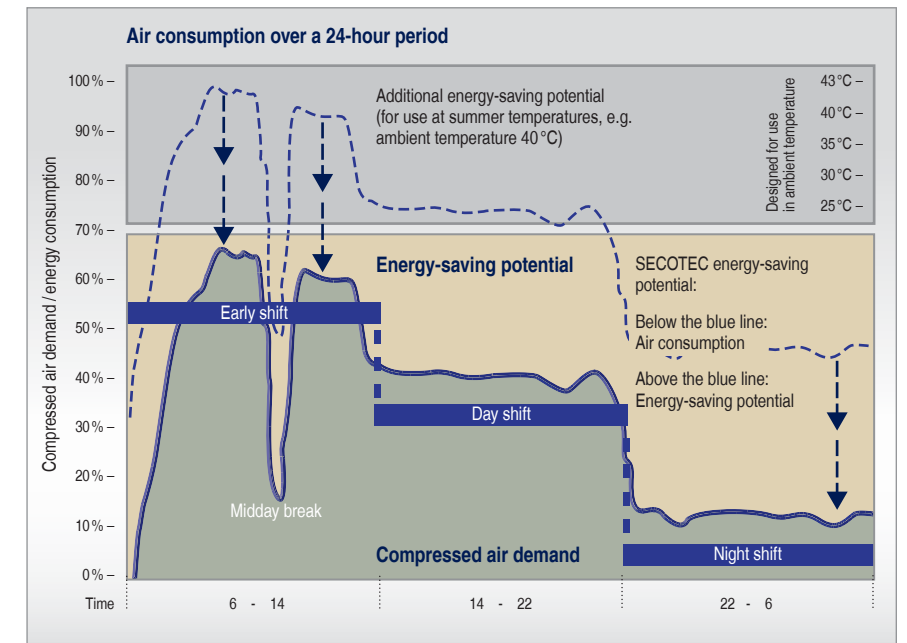

Fig. 3: Energy-saving potential of refrigeration dryers with cycling control

course of a year as a result of large fluctuations in temperature. Therefore, compressed air dryers should be designed to handle the least favourable operating conditions that may occur, for example: lowest pressure, maximum compressed air consumption, as well as maximum ambient and compressed air inlet temperatures.

This requirement used to be solved simply by continuous dryer operation, which – especially in partial load operation – led to considerable energy wastage. Modern refrigeration dryers with efficient cycling control, on the other hand, ensure consistent air quality and are able to adapt their energy usage according to changing operating conditions (Fig. 3). Consequently, they are able to achieve average annual energy savings of more than 50%.

It is particularly important to use energy-efficient technology to reach pressure dew points in the minus range, as the desiccant dryers required to achieve this level of performance have a very high energy demand.

However, using a cost-effective and energy-efficient combination process, such as with the HYBRITEC system, it has been possible to significantly reduce energy consumption. The system comprises both a refrigeration dryer and a desiccant dryer. The refrigeration dryer first brings the inflowing compressed air to a pressure dew point of +3 °C efficiently and cost-effectively. Having been pre-dried, the air then passes into the desiccant dryer, which subsequently requires considerably less energy to dry the air further to a pressure dew point of -40 °C.

Condensate: Correct drainage

Condensate is an unavoidable by-product of compressed air production. We explained how, under average conditions, a 30 kW compressor with a FAD of 5m³/min produces approximately 20 litres of condensate per shift. This liquid must be removed from the air system to prevent system failures, costly production downtime and corrosion. In this chapter we explain how to drain condensate correctly and achieve significant cost-savings at the same time.



Fig. 1: Condensate accumulates at certain points in every compressed air system

1. Condensate drainage

Condensate, contaminated by diverse pollutants, collects at certain points in every air system (Fig. 1). Reliable condensate drainage is therefore essential, otherwise air quality, operational reliability and compressed air system efficiency can be seriously affected.

a) Condensate collection and drainage points

Initially, mechanical elements of the air system serve to collect and drain condensate. 70 to 80% of all the condensate is collected at these points – provided the compressors are fitted with effective after-cooling.

Centrifugal separator:

This is a mechanical separator that separates the condensate from the air by means of centrifugal force (Fig. 2). In order to ensure optimum performance, each compressor should be equipped with its own dedicated centrifugal separator.

Intercoolers:

On two-stage compressors equipped with intercoolers, the condensate also collects at the intercooler's separator.

Air receivers:

As well as its main function as a storage or buffer tank, the air receiver separates condensate from the air by gravity

(Fig. 1). If sufficiently sized (compressor FAD in m³/min divided by 3 = air receiver size in m³), the air receiver is just as effective as a centrifugal separator.

In contrast to the centrifugal separator, however, the air receiver can be used in the main air line of the compressed air system, providing the air inlet is at the bottom and the outlet is at the top. Moreover, due to its large heat dissipation surface area, the air receiver additionally cools the air thereby enhancing condensate separation yet further.

Water-traps in the air line:

To avoid undefined condensate flow, the air line should be designed so that all inlet and outlet points are connected from above or from the side.

Defined condensate outlets leading downwards, so-called water traps, allow condensate to be removed from the main air line. With correct design and an airflow of 2 to 3 m/s a water trap (Fig. 3) in the wet area of the air system separates condensate just as effectively as an air receiver (Fig. 1).

b) Compressed air dryers

As well as those already mentioned, there are additional collecting and

drainage points to be found within the compressed air drying process.

Refrigeration dryers:

Further condensate is separated in the refrigeration dryers due to the drying effect of cooling the compressed air.

Desiccant dryers:

Due to the considerable cooling effect of the air line, condensate can collect at the pre-filter in the inlet to the desiccant dryer. In the desiccant dryer itself, water only exists as vapour because of the partial pressure conditions prevailing in the dryer.



Fig. 2: Centrifugal separator with condensate drain

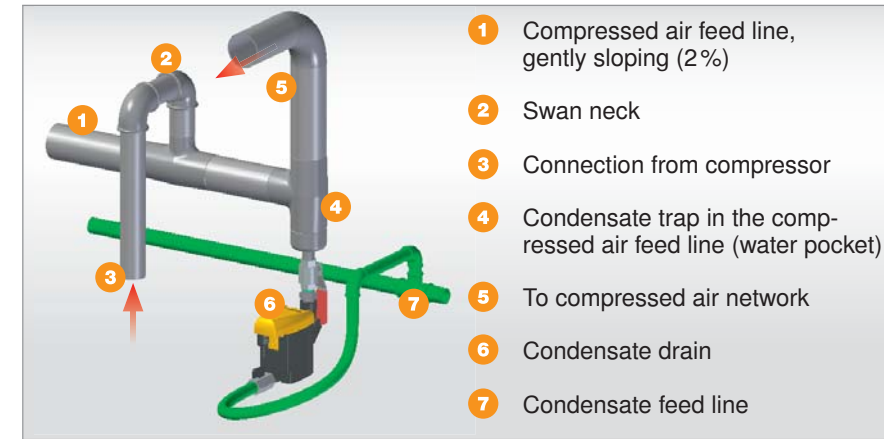

Fig. 3: Water trap with condensate drain in the 'wet' area of a compressed air system

c) Local separators

If no central drying system exists, large quantities of condensate collect at the local separators fitted just upstream from air-consuming equipment. However, these systems are exceptionally maintenance-intensive.

2. Drainage systems

At present, three systems are mainly used:

a) Float drains

The float drain is one of the oldest drainage systems and replaced manual drainage, which was both inefficient and highly unreliable. However, even condensate drainage using the float principle (Fig. 4) proved to be extremely susceptible to malfunction due to dirt and contaminants in the compressed air.

b) Solenoid valves

Time-controlled solenoid valves are more reliable than float drains, but they have to be checked regularly for clogging and contamination. Incorrectly adjusted valve opening periods can cause air losses and increased energy consumption.

- 1 Compressed air feed line, gently sloping (2%)
- 2 Swan neck
- 3 Connection from compressor
- 4 Condensate trap in the compressed air feed line (water pocket)
- 5 To compressed air network
- 6 Condensate drain
- 7 Condensate feed line

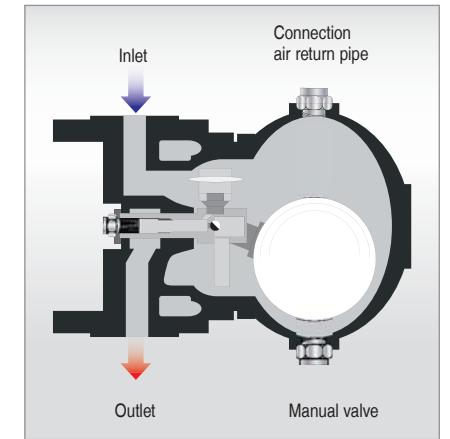

Fig. 4: Float drain for compressed air condensate



Fig. 5: Condensate drain with electronic level-sensing control (ECO-DRAIN)

c) Condensate drains with level-sensing control

Nowadays, drains equipped with intelligent level-sensing control are predominantly used (Fig. 5). They have the advantage that the float, which is highly susceptible to faults, is replaced by an electronic sensor. This eliminates the faults caused by dirt, or mechanical wear associated with float drains. Furthermore, air losses (which also occur with float valves) are prevented by the automatically controlled valve opening periods. Additional benefits include automatic self-monitoring and the ability to send signals to a central control system.

d) Correct installation

A short length of pipe containing a shut-off valve should be fitted between the condensate separating system and the condensate drain (Figs. 2 and 3).

This allows the drain to be isolated during maintenance and the compressed air system can remain in operation.

Condensate: Safe, economical treatment

The term 'condensate' is misleading because it could be misunderstood to mean only condensed water vapour. Be careful! Every compressor works just like an oversized vacuum cleaner: it draws in contaminated air from the surroundings and passes it on in a concentrated form in the untreated compressed air to the condensate.

1. Why treat condensate?

Users who dispose of condensate by simply pouring it down the drain risk heavy fines. Why? Because condensate accumulating during the production of compressed air is a highly noxious mixture. In addition to solid particles, condensate contains hydrocarbons, sulphur dioxide, copper, lead, iron and other substances caused by increased environmental pollution. In Germany, regulations concerning condensate disposal are set out in the Water Management Act. This act stipulates that polluted water must be treated according to the "generally recognised engineering regulations". This affects all types of condensate – including condensate from "oil-free" compressors. There are legal limits for all pollutants and for pH-values. These vary according to federal state and the branch of engineering involved. The maximum permissible limit for hydrocarbons, for example, is 20 mg/l and the pH limit for disposable condensate ranges from 6 to 9.

2. Composition of condensate (Fig. 1)

a) Dispersion

The composition of condensate can vary widely. Generally, dispersion occurs in fluid-cooled rotary screw compressors using synthetic coolants, such as Kaeser's "Sigma Fluid S460" for example. This condensate normally has a pH value between 6 and 9 and can be regarded as pH neutral. With this condensate, pollutants drawn in

from the atmosphere are captured in a floating layer of oil that is easily separated from the water.

b) Emulsion

A visible sign of emulsion is a milky fluid that does not separate even after several days. This composition often occurs in reciprocating, rotary screw and sliding vane compressors that are used with conventional oils. The pollutants are also captured by the oil. Because of the thick, stable mixture, oil, water and pollutants such as dust and heavy metals cannot be separated by gravity. If the oils contain ester compounds, the condensate could be aggressive and must be neutralised. Treatment of such condensate is only possible with emulsion splitting units.

3. Specialist disposal

Of course, it is possible to collect the condensate and have it disposed of by a specialist company. However these costs are typically between €40 and €150 per m³. In view of the amount of condensate accumulated, treatment would be the more economical approach. This method has the advantage that only approx. 0.25% of the original volume is left over to be

disposed of in accordance with environmental regulations.

4. Treatment processes

a) For dispersions

A triple chamber separator comprising two initial separating chambers and an activated carbon filter chamber is used to treat this kind of condensate (Fig. 2). The actual separation process takes place under the force of gravity. The oil layer floating on the surface of the fluid in the separating chamber is skimmed off into a container and disposed of as waste oil.

The remaining water is then filtered in two stages and can be disposed of as waste water. This process saves up to 95% of the costs involved if a specialised company were to dispose of the condensate.

These separators can be supplied to handle compressor air deliveries of up to 105 m³/min. If needed, several separators can be connected in parallel.

b) For emulsions

In general, two types of separator are used for the treatment of stable emulsions:

Membrane separating systems work on the principle of ultra-filtration using the



Fig. 1: Every compressor draws in water vapours and pollutants together with the atmospheric air. The accumulating compressed air condensate (Fig. 1.1) must therefore be free from oil and other contaminants (Fig. 1.2) before it can be drained away as pure water (Fig. 1.3)

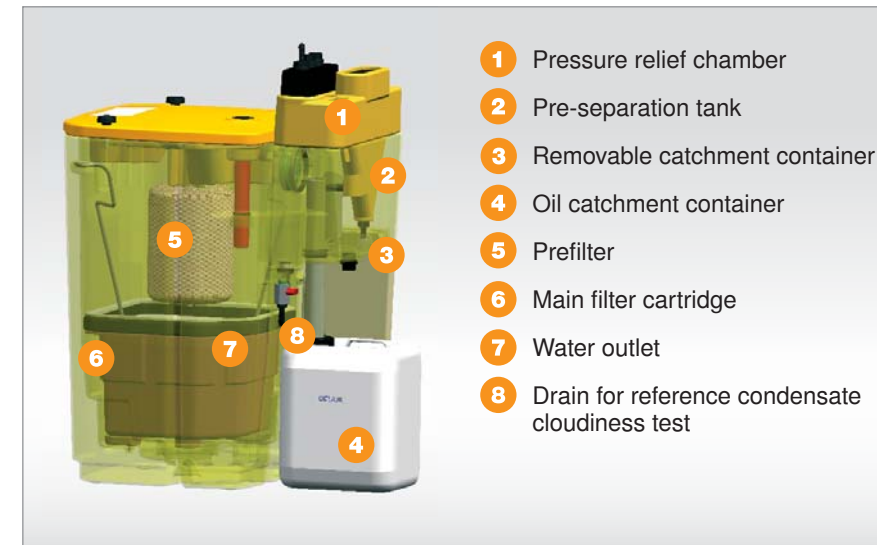

Fig. 2: Condensate separation system for compressed air technology using the gravity principle (functional diagram)

so-called cross-flow process. During this process, pre-filtered condensate flows across the membrane.

A portion of the condensate permeates the membrane and leaves the separator as clean water that can be disposed of as waste water. The second type uses a powdered splitting agent. This encapsulates oil particles, forming easily filtered macro flocs. Filters of a defined pore size reliably retain these flocs. The drained water can be disposed of as waste water.

Efficient compressor control

By correctly matching compressed air delivery to fluctuating compressed air demand, energy-intensive, and therefore costly, partial load phases can be virtually eliminated. The right compressor controller consequently plays a key role in ensuring optimum energy efficiency.

Compressors operating at less than 50% load should set off loud alarm bells with regards to serious energy wastage. Many users are not even aware of this fact because their compressors have an indicator showing only the hours in operation but not the hours under load.

Perfectly matched control systems can help by increasing the load factor to over 90% and by achieving power savings of up to 20% or more.

1. Internal control

a) Full-load/idle control

Most compressors are fitted with three phase asynchronous drive motors. However, the permissible starting frequency of these motors becomes lower in relation to increased motor size. This does not correspond to the starting frequency necessary to cut in and cut out compressors with lower switching differentials to meet the actual air

demand. These switching cycles would only unload the pressurised areas of the compressor system. The drive motor, on the other hand, must carry on running for a certain period to avoid exceeding its starting frequency. (Fig. 1). The power needed to turn the motor during this off-load period must be regarded as a loss. The power consumption of a compressor switched to off-load running is still 20% of full load drive power.

Modern, computer-optimised control systems such as Quadro control with automatic optimal operating mode selection (Fig. 2), Dynamic control with drive motor temperature dependent idling (Fig. 3) and Vario control with variable calculated idling periods (Fig. 4) help to keep costly idling periods to a minimum and ensure maximum motor protection.

Proportional controllers using intake-side throttling are not recommended, since the compressor still requires 90% of the energy it would otherwise need to provide 100% free air delivery, in order to deliver just 50% of maximum capacity.

b) Variable frequency drive

The efficiency of compressors which are speed controlled by a frequency converter (Fig. 5) is inconsistent over the control range. In the control range between 30 and 100% for example, efficiency is reduced from 94 to 86% for a 90kW motor. Added to this are the losses in the frequency converter and the non-linear power characteristic of the compressors. FC-controlled compressors should be operated in the 40-70% control range: this is where they provide optimal performance. These components should be designed for 100% load. If variable speed compressors are inappropriately used for an application, they

can end up consuming a lot of energy without the user ever being aware of the fact. This means that variable frequency drive is not a universal remedy in the search for maximum efficiency and energy-saving operation.

2. Classification of air demand

Generally, compressors can be classified according to function into base load, medium load, peak load or standby-units.

a) Base load air demand

Base load air demand is the volume of air that is constantly needed by a production facility.

b) Peak load air demand

In contrast, the peak load is the volume of air demanded at certain peak load times. It varies in volume because of the differing demand from various consumers.

In order to fulfil this wide range of load demands as best as possible, the compressors need to be equipped with individual control systems.

These slave controllers must be capable of maintaining compressor operation, and therefore the supply of compressed air should a defect occur on the master controller.

3. Master control

Modern master controllers equipped with web-based software are not only able to co-ordinate compressor operation within a compressed air station in order to ensure optimum energy efficiency, but are also able to gather performance data and document compressed air supply efficiency.

a) System splitting

Splitting is the division of compressors of equal or differing capacities and type of control according to base load and peak load air demand of a production facility (Fig. 6).

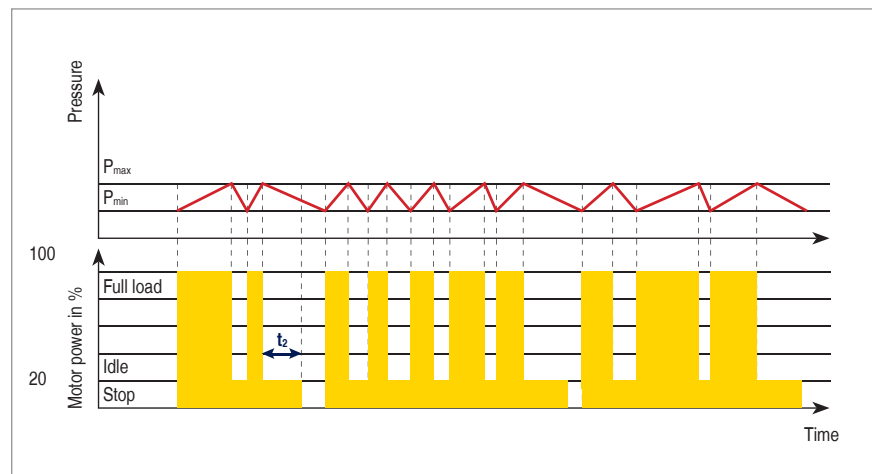

Fig. 1: Full load - Start / stop control with fixed idling periods, so-called Dual control

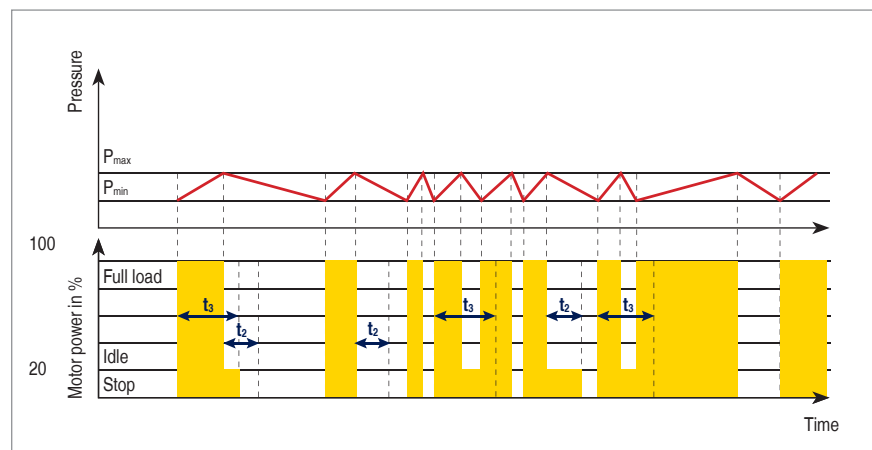

Fig. 2: Full load - Idle - Start / stop control with automatic optimal mode selection, so-called Quadro control

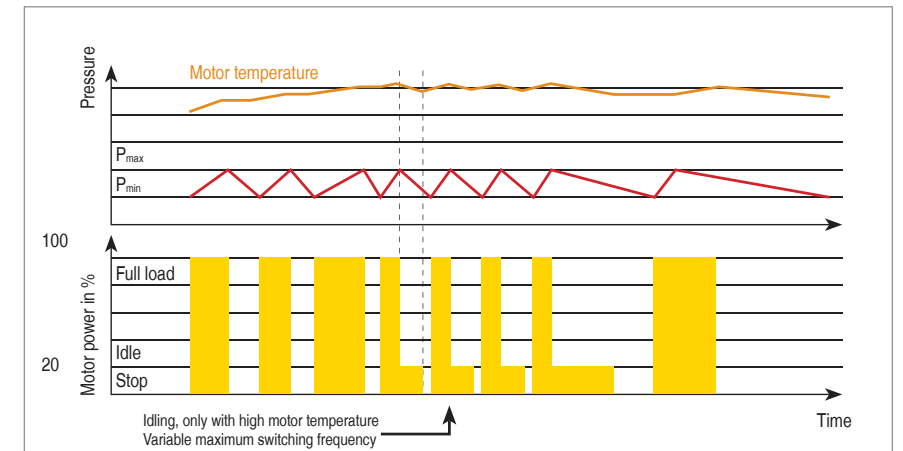

Fig. 3: Dynamic control, based on Dual control, with drive motor temperature dependent idling

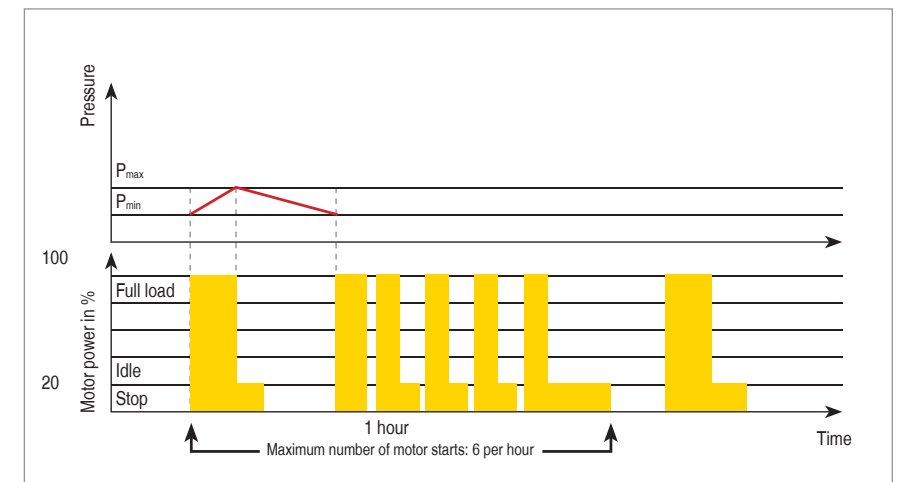

Fig. 4: Vario control with variable calculated idling periods

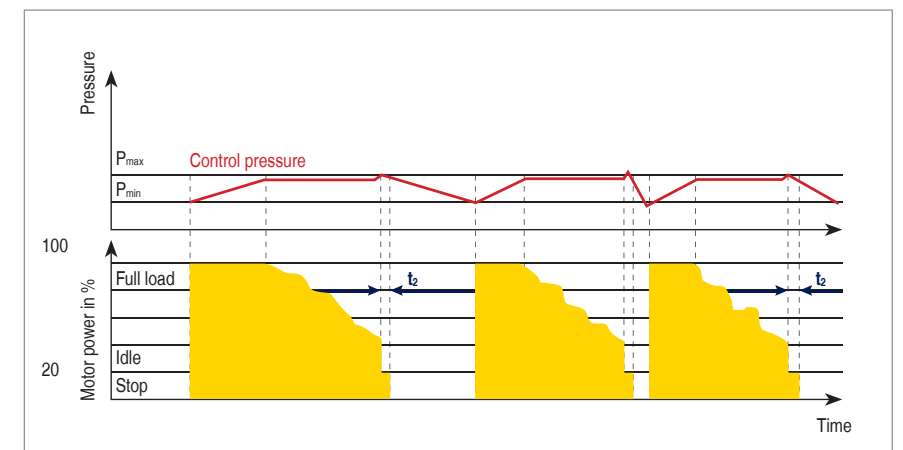

Fig. 5: Continuous delivery control via motor speed (frequency conversion)

Efficient compressor control

b) Master controller tasks

Coordination of compressor operation is a demanding and complicated task. Modern master controllers must not only be able to simultaneously activate and deactivate compressors of differing make and size. They must also be capable of monitoring the system for maintenance purposes, balancing the operating hours of the machines and recording alarms to minimise servicing costs and maximise reliability.

c) Correct grading

For a master controller to operate with maximum efficiency, the compressors within the compressed air station must be perfectly graded. The sum of the air capacities of the peak load machines must therefore be larger than that of the next base load machine to be cut in. If a peak load machine with variable frequency drive is used, the control range must be larger than the capacity of the next compressor to be cut in. Otherwise the

efficiency of the compressed air supply cannot be guaranteed.

d) Secure data transfer

Another important requirement for perfect function and efficiency of a master controller is the safe and secure transfer of data.

It must be ensured that messages are transferable between each compressor and between the compressors and the master controller. In addition, the signal paths must be monitored so that faults such as loss of continuity in a connecting cable are immediately recognised.

The normal transfer methods are:

1. Floating relay contacts
 2. Analogue signals 4 – 20 mA
 3. Electronic interfaces, e.g. RS 232, RS 485, Profibus DP or Ethernet.
- Profibus offers the most advanced data transfer technology. This system can quickly transfer large volumes of data over long distances. When combined with Ethernet and modern telecom-

munications technology, connection to standardised computer and monitoring systems is also possible. This means that master controllers do not have to be located in the compressed air installation itself (Fig. 7).



Fig. 7: The wide range of connection possibilities for a master controller helps to significantly enhance energy-efficient operation of a compressed air station

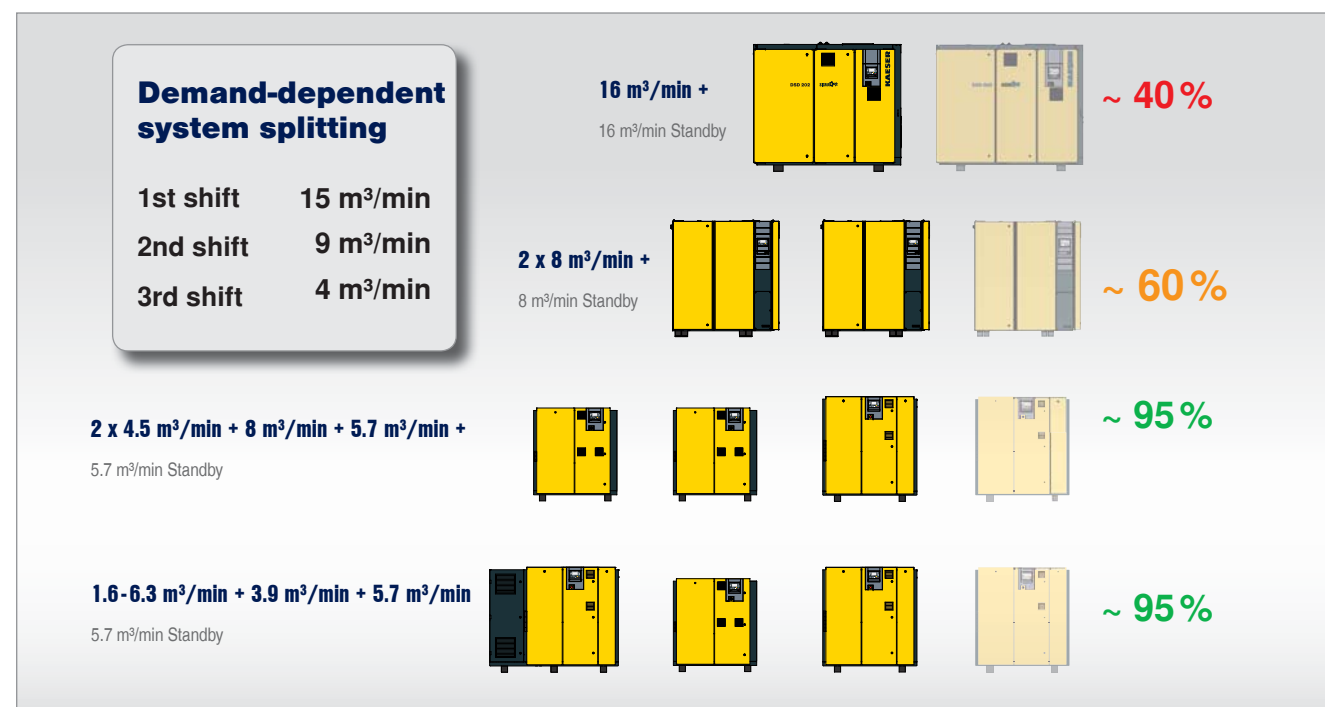

Fig. 6: Demand-dependent load distribution across compressors of differing sizes

Optimised compressor performance to meet actual demand

Compressed air systems typically comprise multiple compressors of similar or various sizes. As effective control is essential to ensure efficient system operation, a master controller is needed to coordinate the operation of individual machines: Compressed air production is precisely matched to suit actual compressed air demand and maximum efficiency is ensured at all times.

Within the scope of regulation and control technology, the systems generally referred to as compressor controllers should be considered as regulating systems. These are chiefly divided into four groups:

1. Cascade control

The classic method of controlling a group of compressors is cascade control. Each individual compressor is assigned lower and upper pressure set points that either add or subtract compressor capacity to meet system demand. If several compressors are to be coordinated, this strategy results in a cascaded, or stepped control system. When air demand is low only one compressor is cut in and pressure rises and fluctuates in the upper range between

this compressor's preset minimum (p_{min}) and maximum pressure (p_{max}) points, pressure falls when air demand is higher and several compressors cut in to meet this demand (Fig. 1, Column 1).

This results in a relatively large, and unfavourable, overall pressure swing with maximum values well above nominal working pressure, increasing the significance of leaks and their subsequent energy losses; on the other hand, if consumption is high, pressure falls well below nominal working pressure and there is a reduced reserve of pressure in the system.

Depending on whether conventional membrane pressure switches, contact pressure gauges or electronic pressure sensors are used as measurement sensors, the control system pressure spread will be very large due to the individual allocation of the compressors to a certain pressure range. The more compressors that are in use, the larger the pressure ranges overall. This leads to ineffective regulation with the already mentioned higher pressures, leakages and energy losses. Cascade regulating systems should therefore be replaced by other regulation methods when used

in combination with more than two compressors.

2. Pressure band control

In contrast to cascade regulating systems, pressure band control (Fig. 1, Column 2) enables co-ordination of multiple compressors within a single defined pressure range. This allows the pressure range within which the compressed air station is regulated to be kept relatively narrow.

2. a) Simple pressure band control

Simple versions of pressure band control are, however, not able to co-ordinate operation of compressors of different sizes; they therefore do not meet the requirements to cover peak load demand in compressed air networks that have to accommodate continuously fluctuating demand conditions.

This method was therefore replaced by a system that, based on periods of pressure fall and rise, aims to control the appropriate compressors and to therefore cover the compressed air peak load demand. This regulation approach does however have a relatively large pressure band spread (Fig. 2). Moreover, similar to cascade control, the reactions of the compressors and the compressed air network are not taken into consideration, which results in a shortfall of the minimum possible pressure dew point. It is therefore necessary to maintain a safety distance between the minimum required pressure and the lowest switching pressure of the regulation system.

2. b) Set pressure oriented pressure band control

Set pressure oriented pressure band control introduced a significant key improvement (Fig. 1, Column 3). This method strives to maintain a certain set pressure and, according to compressed air demand, can control compressors of different sizes. The key advantage

of this regulation variant is that it allows the average operating pressure of the compressed air system to be significantly reduced and therefore helps to achieve considerable energy and cost savings.

3. Demand pressure control

Demand pressure control (Fig. 1, Column 4) is currently the most favourable regulation method. With this variant, no minimum and maximum pressure is specified, just the lowest possible working pressure at which the pressure sensor measurement point is not undershot (Fig. 3). Taking into consideration all possible losses caused by pressure increase, start-up time, reaction and idling periods, as well as speed control of individual units, this regulation method determines optimum performance with regards to switching and compressor selection. Thanks to recognition of individual reaction times, the system is able to ensure that the minimum allowable demand pressure is not undershot (Fig. 4).

With this new variant of adaptive 3D^{advance} Control, which is included in the SIGMA AIR MANAGER 2 (SAM 2) master controller, it is possible to reduce energy consumption even further than with set pressure oriented pressure band control. Moreover, the potential for undershooting of the preset pressure level is eliminated and it is surprisingly simple for the operator to adjust the demand pressure control him-/herself.

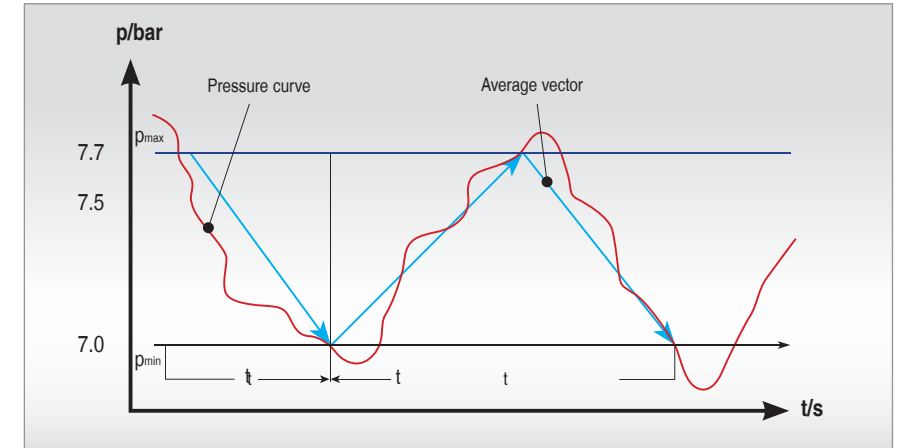

Fig. 2: Optimum pressure is set taking all control-relevant losses into account

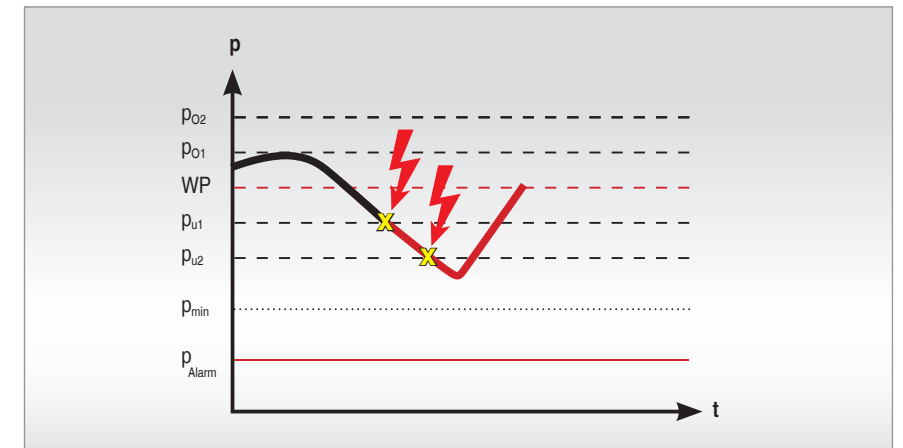

Fig. 3: Input of minimum and maximum pressure limits is not required with demand pressure control

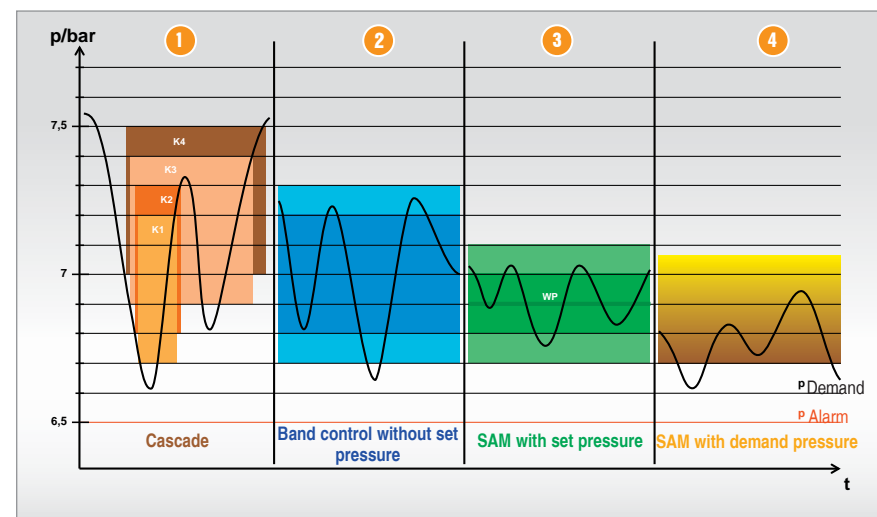

Fig. 1: Different variants of master pressure control

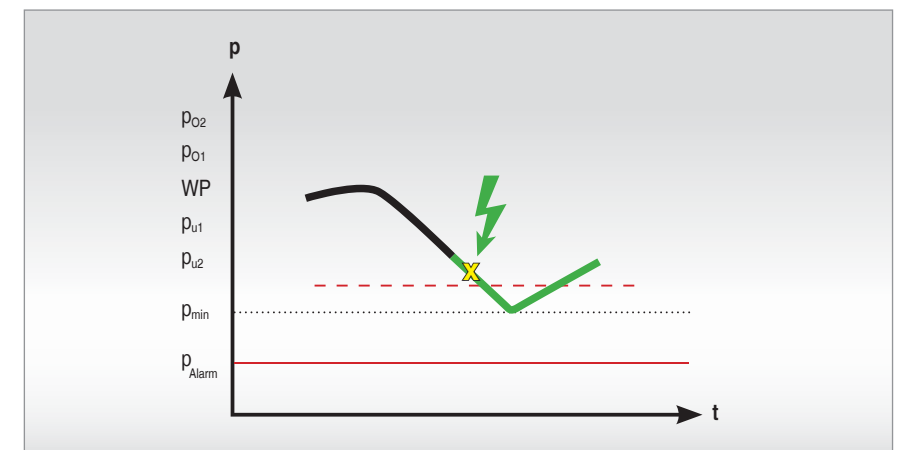
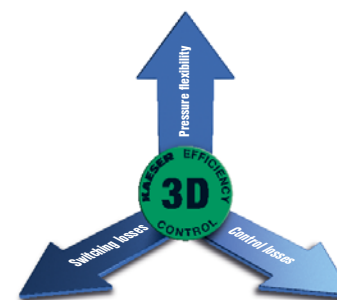

Fig. 4: The system prevents undershooting of the preset minimum demand pressure

Energy savings with heat recovery

In view of ever-increasing energy prices, efficient use of energy is not only important for the environment, but is also increasingly becoming an economic necessity. Compressor manufacturers are able to provide various solutions in this regard, such as heat recovery with rotary screw compressor systems for example.

1. Compressors primarily generate heat

Amazing as it may seem, 100% of the electrical energy input to a compressor is turned into heat. The action of compression charges the air in the compressor with potential energy (Fig. 1). This energy is given up at the point of use by the compressed air expanding and drawing heat from the surroundings.

2. Choices of heat recovery

Compressed air users interested in further increasing the efficiency of their compressed air supply system can choose between various heat recovery options:

a) Air heating

The simplest and most direct method of recovering the heat generated in a fluid-/oil-cooled rotary screw compressor is by using the heat from the compressor system's warmed cooling air. This heated air is ducted away to be used for space heating of warehouses and workshops. The hot air can also be used for other applications such as drying, heat curtains and pre-heating combustion air. When the heated air is not needed, a manual or automatic flap, or louvre, discharges it into the open. The louvre can be thermostatically regulated to maintain a constant, set temperature. The space heating method allows 96% of the electrical energy consumption of a rotary screw compressor to be recovered. It is well worth it too: even small systems, such

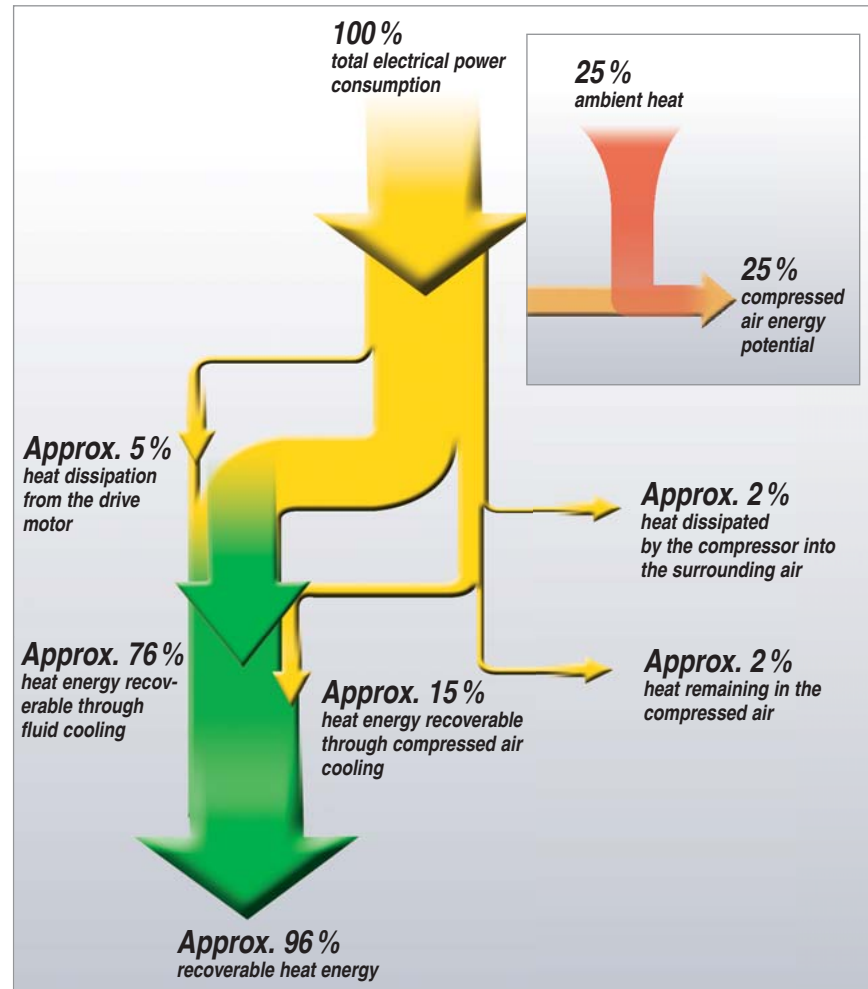

Fig. 1: Heat flow diagram

as a 7.5 kW compressor, can easily generate enough recyclable heat energy to warm a typical family home.

b) Hot water

Hot water for various purposes can be recovered from either an air-cooled or water-cooled rotary screw compressor package by means of a heat exchanger installed in the air/cooling oil circuit. Plate or fail-safe heat exchangers are employed, depending on whether the water is used for heating, laundry or showering, production or commercial cleaning purposes. Water temperatures

Fig. 3: Correct connection of compressors to a heat recovery system



of up to 70 °C can be achieved with these heat exchangers. Experience shows that for compressor packages upward of 7.5kW capacity the additional costs for these heat recovery systems amortise within two years. This of course depends on correct planning.

3. Considerations of reliability

Normally, the compressor's primary cooling system should never be used both for cooling and as a heat recovery system. The reason for this is that if the heat recovery system fails then compressor cooling and, as a result, compressed air production would be endangered. The safest method is to install an additional specialised heat exchanger within the compressor station that is solely responsible for heat recovery. Compressor operation and reliability are therefore safeguarded in the event of a fault: if heat is not dissipated by the heat recovery system's fluid / water heat exchanger, the compressor can revert to its primary air or water cooling system and so continue operation (Figs. 2 and 3).

4. Up to 96 percent usable energy

The major proportion of the energy recoverable as heat, about 76%, is found in the compressor cooling oil, approx. 15% in the compressed air itself and up to 5% is lost through drive motor heat losses. In a fully encapsulated fluid-/oil-cooled rotary screw compressor package even the losses from the electric motor can be recovered as heat energy if appropriate cooling is used. This brings the total proportion of input energy available as heat up to a startling 96%.

Of the remaining energy, 2% radiates away from the compressor package and 2% remains in the compressed air (Fig. 1).

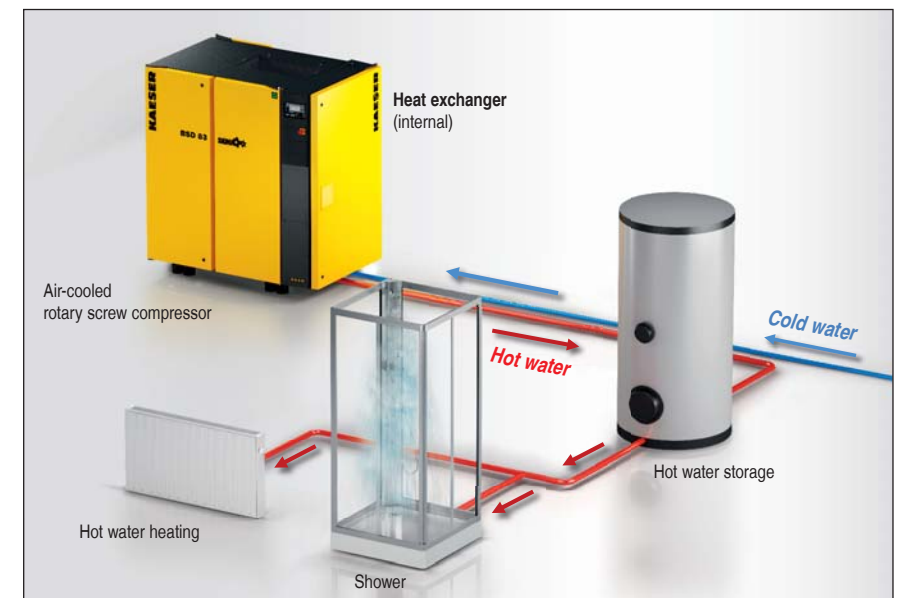

Fig. 3: Heat recovery process

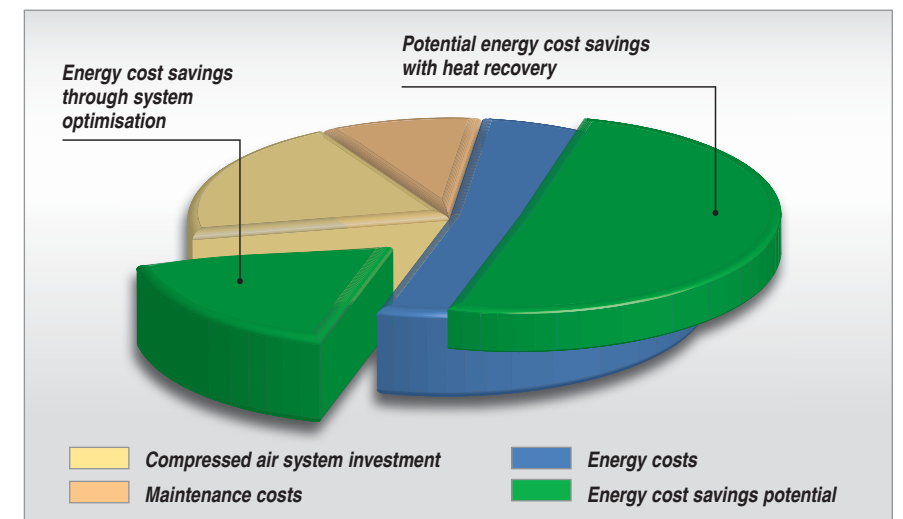

Fig. 4: Heat recovery offers significant additional energy cost savings potential

5. Conclusion

Recovering the heat of compression for a useful purpose is an intelligent way of improving the economics of compressed air production and benefiting the environment at the same time; the effort involved is relatively small. The investment is quickly recovered depending on local circumstances, the

purpose for which the heat is used and the method of recovery chosen (Fig. 4).

Designing and installing a new compressed air distribution network

Compressed air is an efficient source of energy provided that its production, treatment and distribution components are perfectly matched with one another. Moreover, correct system design and appropriate sizing and installation of the air distribution network are also essential.

1. Economical compressed air production

When the cost of energy, cooling medium, maintenance and equipment depreciation is taken into account, the cost of each cubic metre of air produced, depending on the compressor size, utilisation, condition and model, is between 0.5 and 2.5 cents (Euro). Many production facilities place great importance on highly efficient compressed air production. This is one of the key reasons why fluid-oil-cooled rotary screw compressors have become so popular: They can reduce compressed air production costs by as much as 20% compared with other types of compressor.

2. The influence of air treatment on the air main

However, less consideration is given to ensuring application-specific compressed air treatment. This is a shame, since only correctly treated air can reduce the maintenance costs of air consumers and associated pipework. Wherever pipework conveys moisture-laden, non-dried compressed air, it is essential that corrosion-resistant pipework is used. Care should also be taken to ensure that inadequate pipework does not negatively impact the compressed air quality achieved by the treatment system.

a) Refrigeration dryers reduce maintenance requirement

Refrigeration drying provides an air quality sufficient to meet 80% of all applications. Refrigeration dryers often

eliminate the pressure losses associated with in-line filters in the air network and consume only approx. 3% of the energy that the compressor would otherwise use to make up for these pressure losses. In addition, the saving in costs for maintenance and repair of air-consuming equipment and pipework can easily amount to ten times the average cost of refrigeration drying.

b) Space-saving combination systems

For smaller or local applications, space-saving compressed air packages comprising a rotary screw compressor, a refrigeration dryer and air receiver (Fig. 1) are also available.

3. Designing and installing an air distribution network

When designing a new compressed air installation, one of the key factors to consider is whether it should be designed as a centralised or a decentralised system. A centralised system is usually suitable for smaller and mid-sized businesses, since many of the problems that occur in larger systems do not generally arise, e.g. high instal-



Fig. 1: The all-in-one AIRCENTER compressed air package for space-saving compressed air production, treatment and storage

lation cost, freezing of inadequately insulated external piping in winter, or increased pressure drops caused by long sections of piping.

a) Correctly sizing the network

A calculation must always be used to correctly size air distribution piping. This calculation is based on the rule that the maximum pressure drop between the compressor and the air-consuming equipment (including standard air treatment, i.e. refrigeration drying) should be no greater than 1 bar. The following individual pressure losses should be taken into account (Fig. 2):

① Air-main	0.03 bar
② Distribution piping	0.03 bar
③ Connection piping	0.04 bar
④ Dryer	0.20 bar
⑤ Filter/regulator/lubricator unit and hoses	0.50 bar
Total max.	0.80 bar

The importance of calculating the pressure drops in the individual piping areas becomes apparent when they are itemised in this way. Shaped components and shut-off units should also be taken into consideration. Therefore it is not enough to just simply input the number of metres of straight piping into a calculation formula or table, as the actual technical flow length of the piping has to be determined. During the initial system-planning phase however, the calculation figure for all shaped components and shut-off units is usually unclear. Hence, the flow length of the piping is calculated by multiplying the number of metres of straight piping by a factor of 1.6. The piping diameter can then be easily determined by referring to tried and tested formulas (Fig. 3) or design diagrams (Appendix 1, pg. 54). A design diagram can also be created via the KAESER Toolbox (www.kaeser.de/online-services/toolbox).

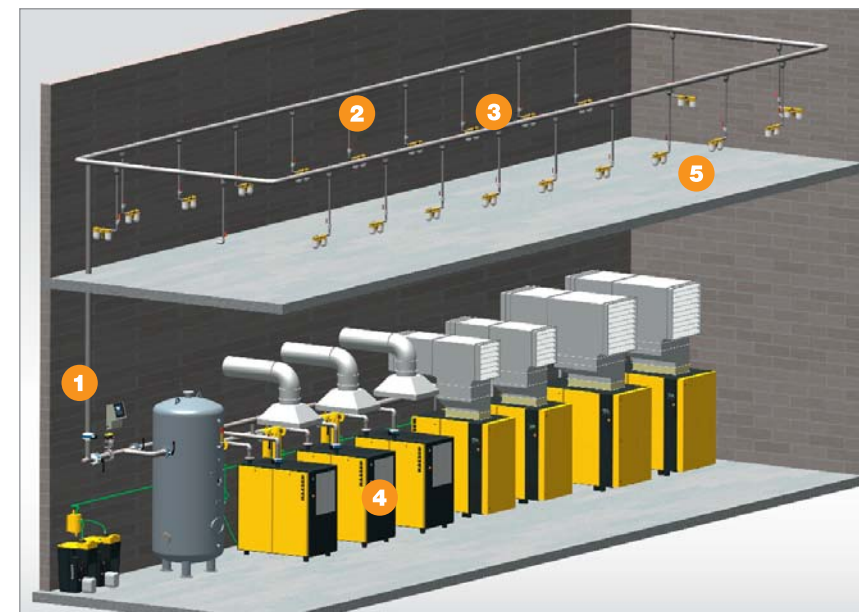

Fig. 2: Main components of a compressed air distribution system: Air-main (1), Distribution piping (2), Connection piping (3), Dryer (4), FRL unit/hose (5)

Approximation formula:

$$d_i = \sqrt[5]{\frac{1.6 \times 10^3 \times V^{1.85} \times L}{\Delta p \times p_s}}$$

d_i = Internal pipe diameter (m)
 p_s = System pressure (absolute in Pa)
 L = Nominal length (m)
 V = Flow volume (m³/s)
 Δp = Pressure loss (Pa)

Fig. 3: Approximation formula to determine pipe diameters

b) Installing energy-saving pipework

In order to save energy the pipe layout should be as straight and direct as possible. For instance, one can avoid bends in laying pipe work around an obstacle by repositioning the run in a straight line alongside it. Sharp, 90° corners cause high pressure drops and should be replaced with large-radius elbows. Instead of the commonly-used water shut-off valves, ball or butterfly valves with full through-flow bores should be used.

In wet pipework areas, e.g. only the compressor room in the case of modern air systems, pipe connections to and from the main line should be made from above or at least from the side. The main line should have a drop of 2 in 1000. The possibility of connecting a condensate drain should be provided at the lowest point in this line. In dry areas the pipeline can be horizontal with branch lines connected directly downwards.

c) Which piping material?

No specific recommendation can be made with regard to material properties. However, due to the high thermal loads associated with compressors, metallic piping should always be used. The investment price alone provides little help in making a decision, as galvanised steel, copper and plastic pipes all cost about the same when material and installation costs are added. Stainless steel piping is about 20% more expensive. However, more efficient processing methods have allowed prices to drop in recent years.

Most manufacturers offer tables in which the optimal conditions for every pipe material are given. It is advisable to study tables such as these before making a decision, to take into account the loads placed on the air main during normal operation in the future and then to create specifications for the pipework accordingly. This is the only way to ensure a truly effective air main system.

d) Important – correct jointing

The pipes should be jointed either through welding, with adhesive or screwed with adhesive. It is especially important that the jointing is correctly carried out to ensure a mechanically sound and leak-proof joint, even if it is difficult to take them apart again.

Optimising an existing air distribution network

A huge amount of cash is needlessly wasted year in, year out due to ageing or poorly maintained air distribution systems which allow valuable energy to escape unused. Resolving these deficiencies requires considerable thought and involves a lot of hard work. Here are some useful tips for correct refurbishment and modernisation of compressed distribution systems.

1. The basic requirement: Dry compressed air

When planning a new air main, mistakes leading to problems in the future can be avoided. Modernisation of an existing compressed air main is not always straightforward and is pointless if the air being fed into the distribution network contains moisture. Before beginning such work, make sure the air is dried at source.

2. What if there is an excessive pressure drop in the air distribution network?

If the pressure drop in the main is excessive, even after a satisfactory treatment system has been installed, then the cause is probably deposits in the pipes. Contaminants carried in the compressed air are deposited on the pipe walls, reducing their effective diameter and narrowing the passage through which air flows.

a) Replacement or blow out

If the deposits are firmly encrusted there may be no alternative but to replace sections of pipe. However, it is possible to blow out the pipes if the inside diameter is only slightly narrowed by deposits, followed by thorough drying before bringing them back into service.

b) Installing supplementary lines

A good way of increasing the effective diameter of a spur line is to connect a second pipe in parallel with it. A supplementary

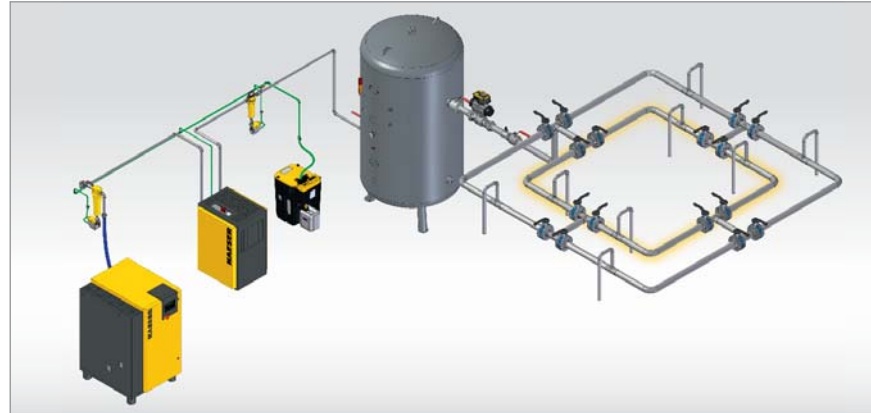

Fig. 1: Modernising a compressed air distribution line through installation of a supplementary ring main

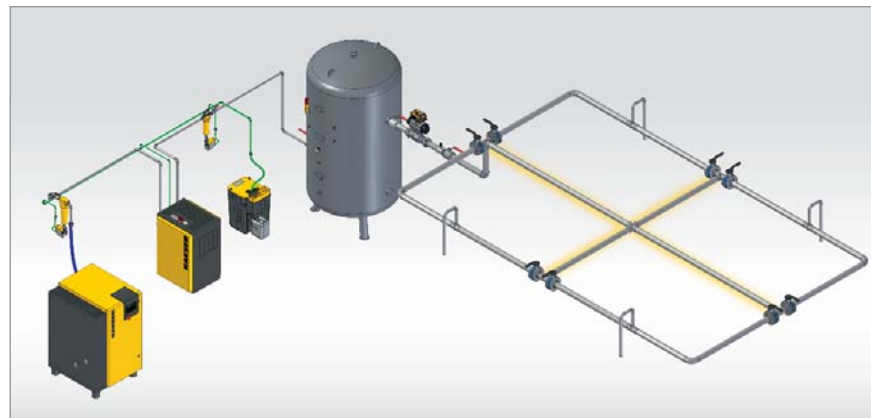

Fig. 2: Expansion of distribution pipework capacity using cross-connection lines

ring main can also be laid if the inside diameter of the original ring is too narrow (Fig. 1).

If correctly sized, a supplementary spur line or double ring not only relieves the pressure drop problem but also increases the reliability of the distribution network in general.

A further possibility for improving the airflow in a ring main is to expand the system by using cross-connection lines (Fig. 2).

3. Identifying and rectifying leaks

A primary objective of any modernisation project must be to stop, as far as possible, leakage of air in the main network.

a) Determining total leakage losses

The scope of the overall air leakage loss should be determined before searching for individual leaks in the network. This is done relatively simply with the help of a compressor – all air consumers are left connected but switched off and the cut-in times of the compressor are measured over a specific period (Fig. 3). The results are then used to determine leakage with the following formula:

$$VL = \frac{VC \times \sum t_x}{T}$$

Key:

VL = Leakage volume (m³/min)

VC = Compressor flow rate (m³/min)

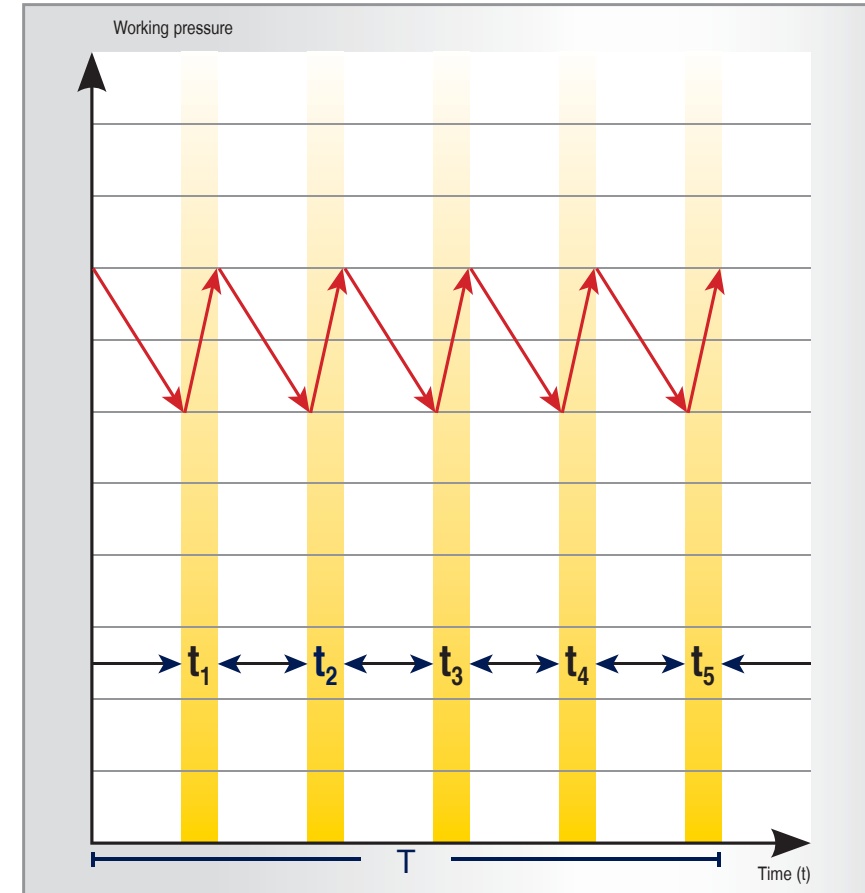

Fig. 3: Determining total leakage by measuring compressor cut-in times with all consumers switched off

$$\sum t_x = t_1 + t_2 + t_3 + t_4 + t_5$$

Time that the compressor ran on-load (min)

$$T = \text{Total time (min)}$$

b) Measuring leakages at the air-consuming equipment

In order to determine leakage losses in decentralised compressed air consumers, all pneumatic tools, machines and equipment should first be connected and the sum of all leakages should be measured (Fig. 4). Then, the shut off valves upstream of all air-consuming equipment are closed and the measurement is made again to determine the leakage in the air distribution network (Fig. 5).

The difference between the total and network leakage is the leakage caused by the air-consuming equipment and their fittings.

4. Where do most leakages occur?

Experience shows that 70% of leaks from an air main occur in the last few metres of the network, i.e. at or near the air take-off point. These leaks can usually be pinpointed with the help of soap suds or special sprays. The main pipe work is only a source of significant leakage if old hemp seals in an originally damp network that have been kept damp by the moist air then dry out when the network is fed by dry air. Leaks in main air pipe distribution networks are best detected with the aid of ultrasonic equipment. When the last leak has

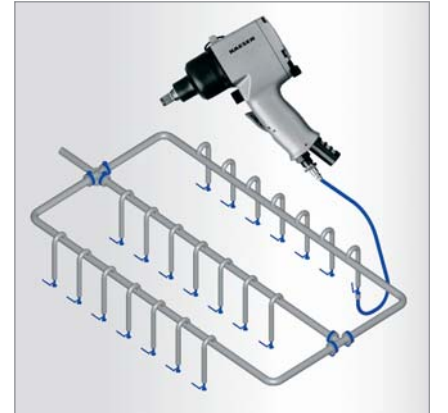

Fig. 4: Leakage measurement of compressed air consumers + air distribution network

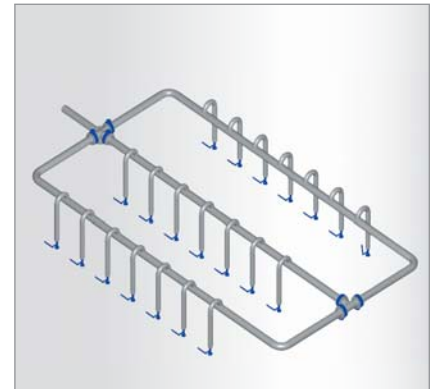

Fig. 5: Leakage rate of air distribution network

been located, removed and the effective diameter of the pipeline is sufficient for the flow rate required, then the old air main has (once more) become an efficient air distribution system.

Compressed air demand analysis (ADA) – Determining the current situation

Modern compressed air installations are usually highly complex systems. They are only able to operate at the peak of their performance if this aspect is properly taken into account during all stages of system planning, expansion and modernisation. KAESER has developed a comprehensive service tool to aid these processes. It combines familiar elements such as compressed air components, customer consultation and advice with modern advances in compressed air engineering information technology.

Compressed air is used in more applications than one can possibly imagine. But, the common prerequisite for efficient use of compressed air is the reliable production and treatment of the air itself. The air system must be able to deliver the air cost-effectively in the specified quantity and at the required quality.

1. Consultation influences efficiency
An air system is cost effective only if it suits the application for which it is intended and fits the location and the conditions under which it operates. In

other words: the compressors, air treatment equipment and pipe work must be correctly chosen, sized and controlled. Furthermore, there must be adequate ventilation and a means of dealing with accumulating condensate and, if possible, there should be a means of recovering the exhaust heat generated by the compressors. The “KAESER Energy Saving System” (KESS) covers all of these aspects and more as it comprises air demand analysis, planning (Fig. 1), implementation, further training and exceptional customer service.

The deciding factors are the quality of the consultation and selection of the correct technology, since the greatest potential for cost savings with any compressed air system lies in efficient power consumption and minimal maintenance requirement rather than in the initial purchase price.

2. Air Demand Analysis

Detailed investigation into the user's current and possible future compressed air requirements form the basis of every KESS analysis.

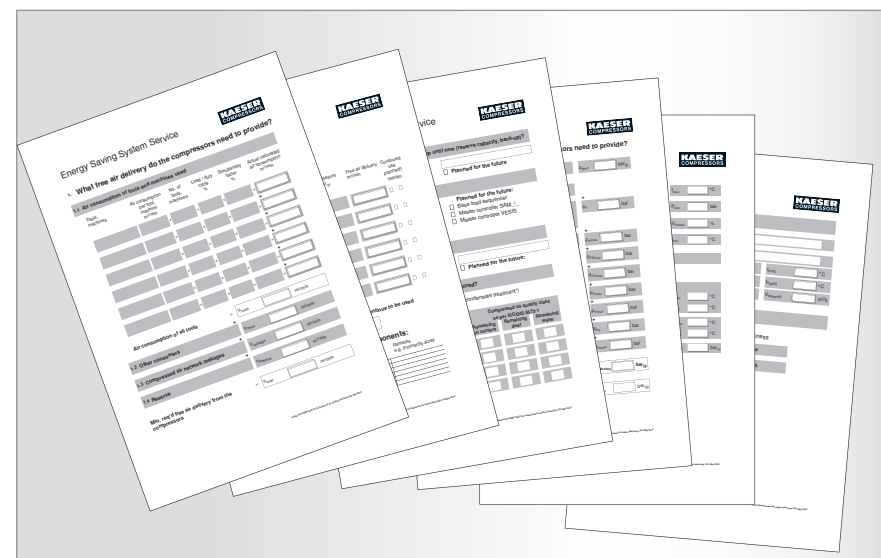

Fig. 2: Compressed air station questionnaire to gather information regarding new and existing systems (also see Appendix, Page 56 f.)

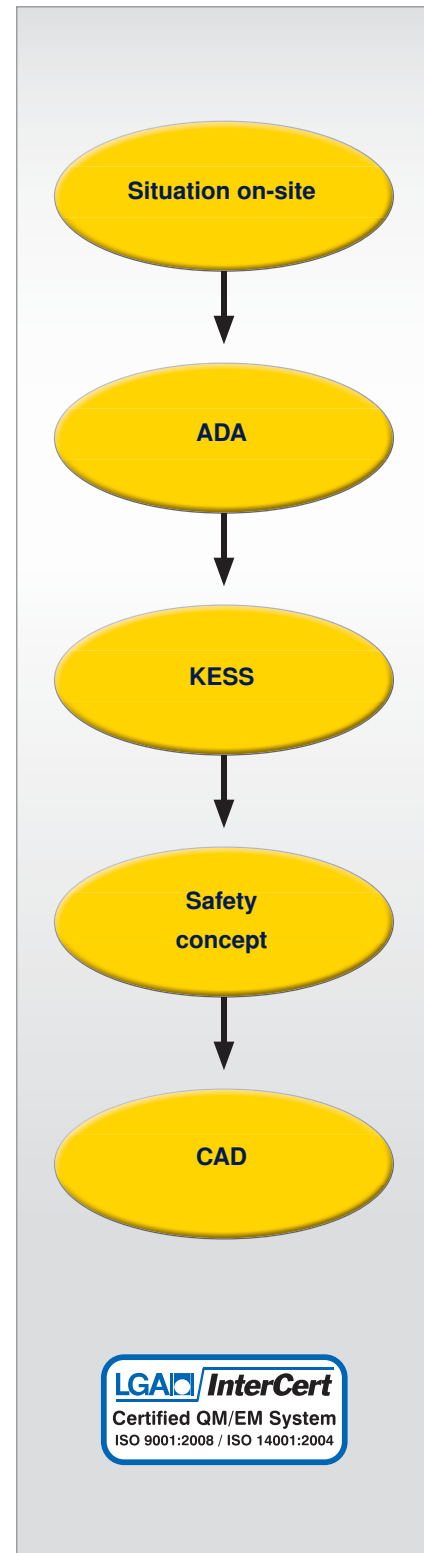

Fig. 1: KAESER Kompressoren's compressed air analysis system

This computer-aided process, developed by KAESER and called ADA (Air Demand Analysis), has to take the specific circumstances of the application into account:

a) Designing a new air supply system

When planning a new compressed air supply system, the future operator is first given a special design questionnaire (Fig. 2). A KAESER consultant can then interpret the provided information to determine what system equipment would be required in order to best meet the needs of the specific compressed air application. The questions cover every aspect of what comprises an efficient and environmentally-friendly compressed air supply system.

b) Expansion and modernisation

In contrast to new projects, expansion or modernisation programmes involving existing systems usually provide sufficient reference points for new application-tailored design solutions. KAESER provides measuring instruments and data loggers with which the air demand is precisely determined in various locations and at different times. It is particularly important to determine maximum and minimum as well as average values (Fig. 8, pg. 29).

c) Testing the efficiency of an existing air system

It is recommended that the efficiency of an existing air system is checked from time to time with the help of a computer-aided analysis method that determines whether the compressors are (still) correctly loaded, whether the control systems are (still) correctly programmed and whether leakage rates are still within an acceptable tolerance range. ADA should also be used if compressors are to be replaced by new machines. This will avoid possible errors in capacity selection that may lead to inefficient

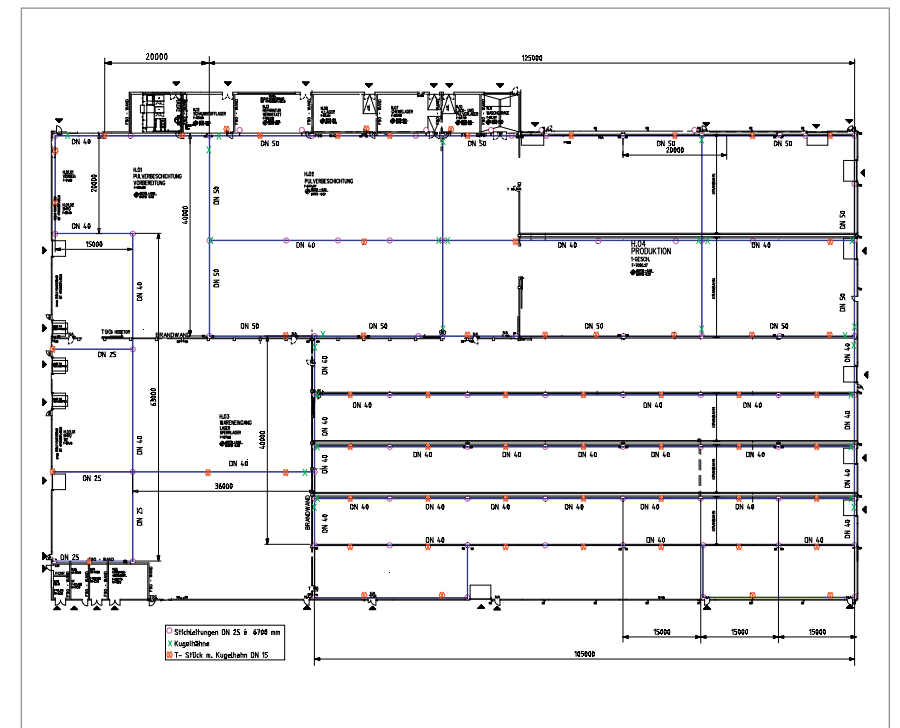

Fig. 3: Layout of a compressed air distribution network

duty cycles (partial load range) and will also assist in the selection of a suitable master control system.

d) Changes in operating conditions

It is well worth consulting a specialist when the conditions under which an air system operates change. Often simple changes to air treatment methods or pressure matching can be made to suit the new circumstances, achieving significant cost savings.

3. Operator information

a) Layout plan

A layout plan of the production facility should be available for general orientation (Fig. 3). It should show the compressed air station's compressed air main, connection lines and feeder line connections. Details of pipe diameters and materials, the main air take-off points and any take-off points for air at special pressures and qualities must also be shown.

b) Compressed air applications

As compressed air is a highly versatile medium, it is essential for the user to provide exact details regarding the specific air application: Given information should include, for example, whether the air is to be used as control air, for surface treatment, for rotating tools, for cleaning or as process air, etc.

c) Installed compressors

As well as model and type, the compressors' technical data – such as working pressure, free air delivery, power consumption, type of cooling and use of heat recovery – should also be mentioned.

d) Compressed air treatment

As far as air treatment is concerned, it is important to know whether the air is treated centrally or locally and what classes of quality are required. Obviously, the technical specifications of the components should be listed and a flow

Compressed air demand analysis (ADA) – Determining the current situation

diagram provides the necessary overview (Fig. 4, pg. 28).

e) Compressor control and monitoring

As the efficiency of a compressed air system is significantly affected by the characteristics both of the individual compressors and they way they interact with one another, it is also important to include details regarding the control and monitoring systems that are used.

4. Discussions between the user and specialist

Once the above information is made available, the compressed air specialist should be familiarised with the relevant documents and then a discussion should follow detailing any issues with the air supply. Such issues might include: low or fluctuating pressure, poor air quality, inadequate utilisation of compressors or problems with cooling.

5. Inspection

The most revealing phase is an inspection of the compressed air system. This should always start in the most critical zone, i.e. where the greatest pressure drops or poor air quality are to be expected (Fig. 5). Experience shows

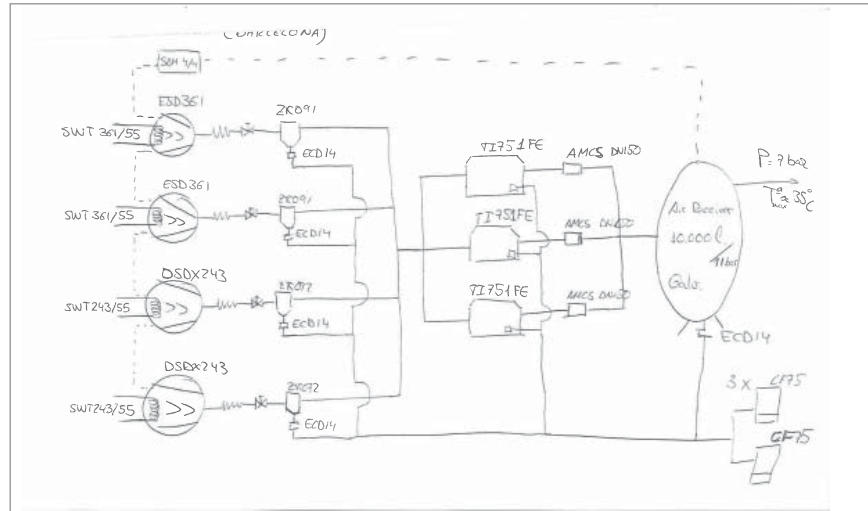

Fig. 4: Hand-drawn P & I diagram of a compressed air station

that these are often the final compressed air take-off points.

a) Connection hoses, pressure regulators, water separators

The hose connections to the air consuming equipment are highly susceptible to leaks. These should be thoroughly checked. If pressure regulators are installed then their pressure settings (inlet and outlet pressure) should be checked under load (Fig. 6). Water separators installed upstream from pressure regulators should be

checked for fluid accumulation and contaminant build-up. The same applies to drainage pipes that lead straight down (Fig. 7).

b) Shut-off valves

Distribution lines and their fittings leading away from the main line significantly affect system efficiency. Shut-off valves and similar equipment also play an important role: they should be adequately sized, full-flow ball or butterfly types, not inefficient water taps or angle valves.



Fig. 6: Maintenance unit with pressure regulator

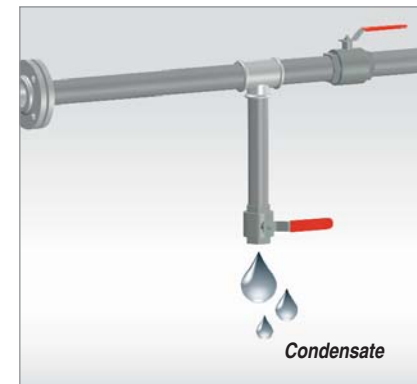

Fig. 7: Check compressed air branch lines for moisture

c) Main ring

The most important point is to detect causes of pressure drops such as narrowed sections.

d) Compressed air treatment system

The most important inspection criteria here are the pressure dew point achieved (degree of dryness) and the pressure drop across each component. Further quality checks may be required depending on the application.

e) Compressed air station

Of course the compressed air station itself may have its own shortcomings. In particular, the location of the compressors, ventilation, cooling and pipework should be checked. Furthermore, the cumulative pressure swing of the compressors, the size of the air

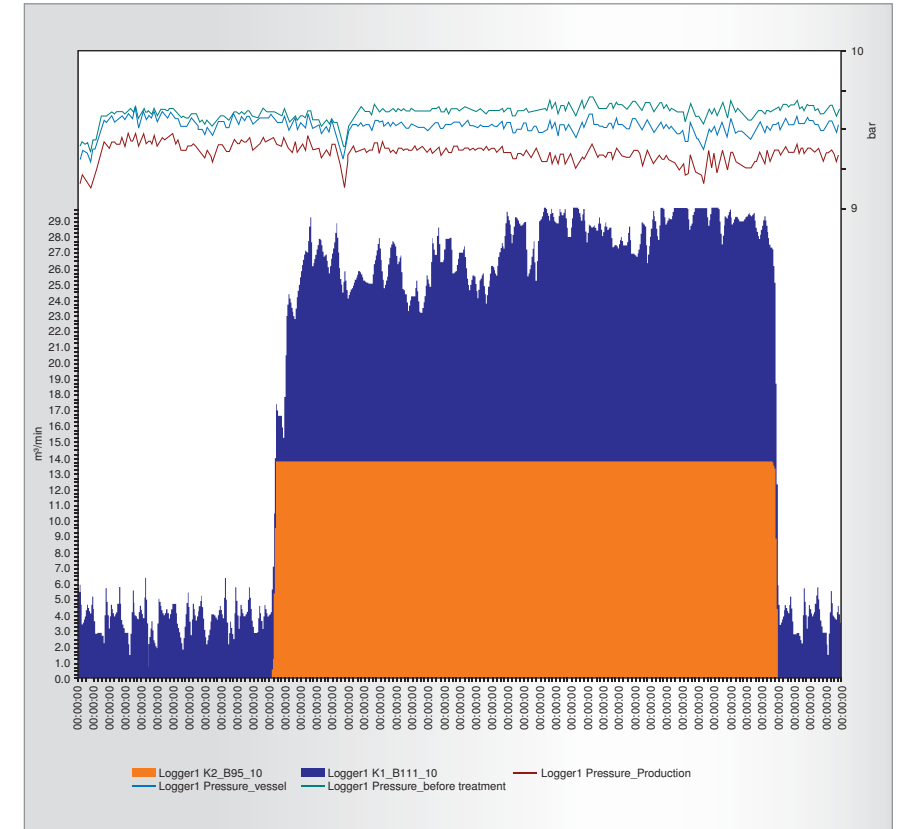

Fig. 8: A business's pressure and compressed air consuming structure measured with ADA.

receiver and the location of the pressure measurement points from which the compressors are controlled must be checked.

f) Determining ADA measurement points

When the inspection is completed, the specialist and the user decide on the points at which the measurements are to be taken. The minimum requirement is to measure points upstream and downstream of the air treatment system and at the outlet of the compressed air distribution network.

6. Measurement of pressure and air consumption (ADA)

During measurement of pressure and air consumption, the operation of the compressed air system is monitored

over a period of at least 10 days with the help of advanced data logger technology. The data logger collects all relevant information and transfers it to a PC which uses this data to create an air demand profile. The graph shows pressure drops, fluctuations in pressure and consumption, off-load profiles, on-load and standstill periods of the compressors and the relationship of individual compressor performance to respective air consumption. In order to complete the picture, the leaks also have to be determined during this measurement process. This is carried out as described in Chapter 10, (pg. 24 f.) and requires selective closure of defined sections of the air main over the course of a weekend.

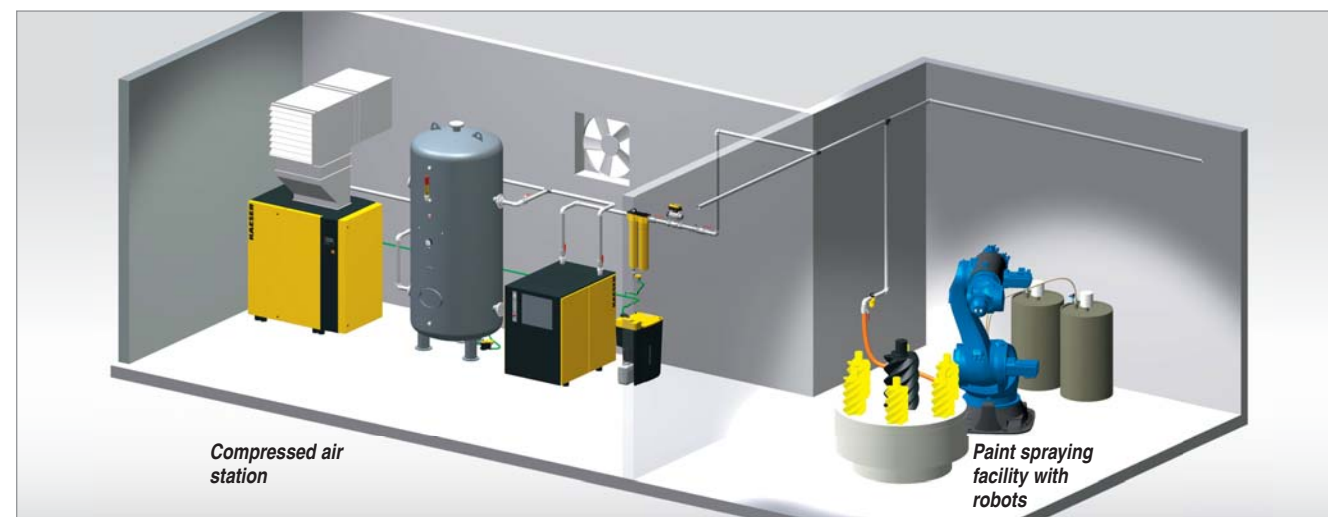

Fig. 5: Insightful: compressed air system inspection

Determining the most efficient concept

With meticulous compressed air system optimisation, it is possible to save more than 30% of average European compressed air costs for industrial businesses. Approximately 70 to 90% of these costs are accounted for by energy demand. In view of ever-increasing energy prices, it is therefore more important than ever for users to determine and implement the most efficient compressed concept for their business.

Using the optimisation calculation from the KAESER Energy Saving System (KESS), it is possible to compare various system solutions for the specific application in question and identify the most efficient. For new systems, the completed design questionnaire provides the basis for this calculation. For existing air systems the calculation is based on the characteristic daily profile determined by an Air Demand Analysis (ADA) (see pg. 29, Fig. 8).

1. Computer-aided analysis

Before an existing air supply system can be optimised, all the technical data relating to it and any possible new alternatives are entered into the KESS software. KESS then identifies the optimum system design and calculates the potential cost savings. Moreover, the momentary power consumption at a defined air demand, including all losses, is also calculated.

It is also possible to establish a precise picture of the specific power profile of the air system throughout the entire running period (Fig. 1). This means that any weak points in partial load operation can be detected in advance and remedied. The overall result is a clear statement of the potential cost savings and amortisation period.

2. It's the mix that counts

In most cases a precisely co-ordinated configuration of compressors of different capacities has proven to be the best

solution. The mix generally consists of large capacity base load and standby compressors combined with smaller peak load machines.

The master controller's task is to ensure the best possible balanced specific power requirement. To do this it must be able to automatically select the most appropriate combination of base-load and peak-load machines from up to 16 compressors working within a pressure band of only 0.2bar. Intelligent master control systems such as KAESER's SIGMA AIR MANAGER meet

these needs and enable highly sophisticated system control. In addition, they can be connected to centralised control systems, as well as other compres-

sors and additional components such as condensate drains, dryers, etc. and allow data exchange via a powerful bus system.

3. Structural optimisation

A newly designed or modernised air supply system should make optimum use of the space in which it is to be installed. Modern design systems such as those used by KAESER provide worthwhile support in this regard. During the design process they not only make use of floor plans and P & I diagrams, but also use advanced 3-D computer-generated plans and animations. This means that it is often possible to take advantage of efficient air-cooling despite cramped conditions

in the compressor room. Air-cooling saves between 30 and 40% of the costs normally associated with water-cooled systems (Figs. 2a to c).

4. Operational optimisation and controlling

In order to ensure compressed air system efficiency over the long-term, it is essential to have an optimised cost/use ratio and complete transparency via an effective control system. This is where KAESER's integrated PC-based SIGMA CONTROL comes into its own, as it features five pre-programmed control modes and is able to gather data and transfer it back to a data network. At the master control level a further industrial computer is used: the SIGMA AIR MANAGER (mentioned earlier on page 18). Its task, as well as appropriate control and monitoring of the air supply system, is to collect all relevant data and pass it on to a computer network (Ethernet). This can take place via Internet or via the SIGMA CONTROL CENTRE centralised control software. Together with the SIGMA AIR CONTROL visualisation system, this PC-installed software can display a list of all the air compressors and their key operational data. This shows at a glance whether the system is functioning correctly, whether maintenance or alarm messages are activated and how high system pressure is.

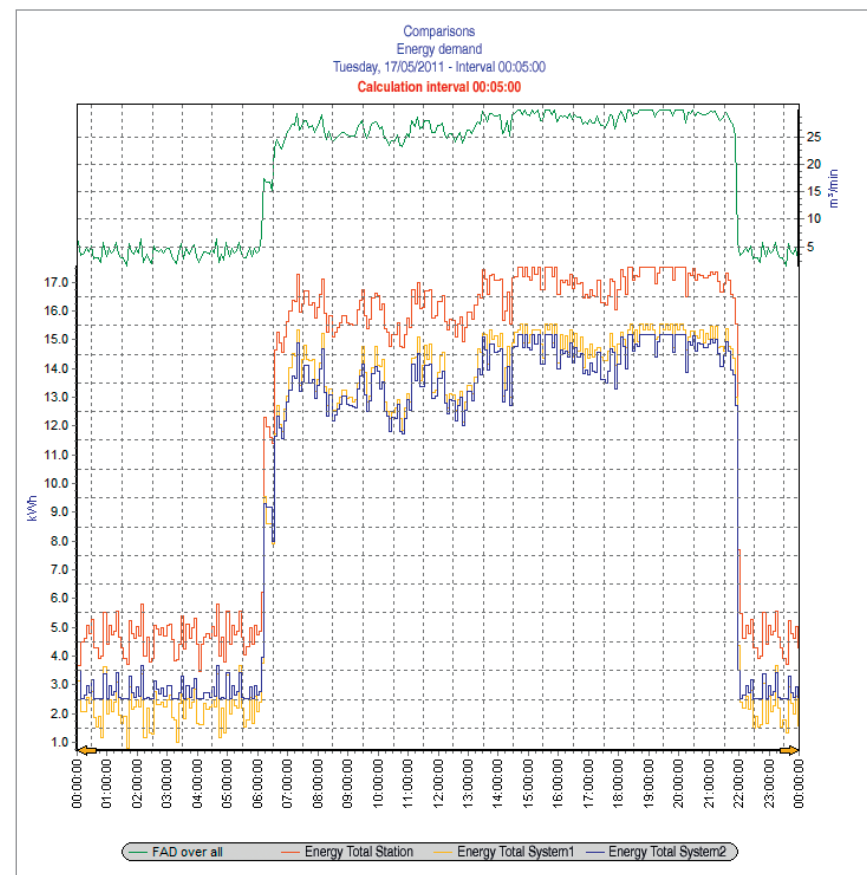

Fig. 1: Comparison of the power consumption of an existing air supply system with new alternative systems over a one-day period related to air demand

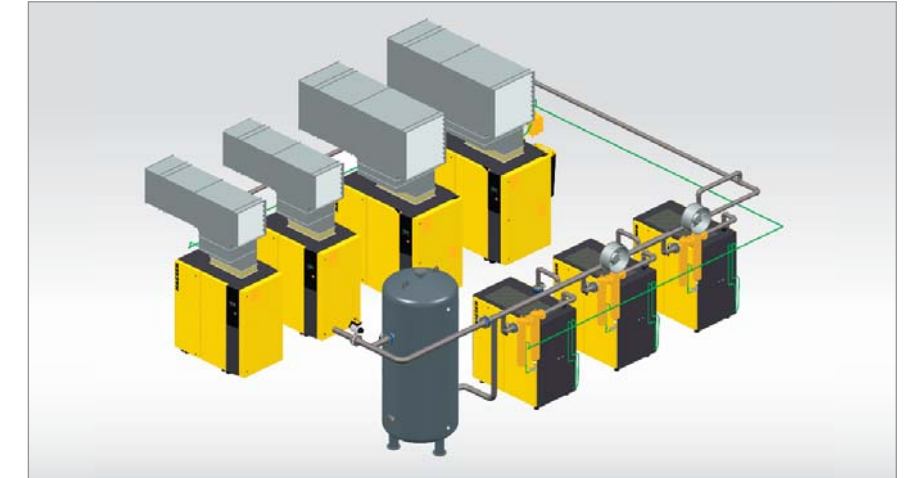

Fig. 2a: CAD-optimised 3-D planning of a compressed air station

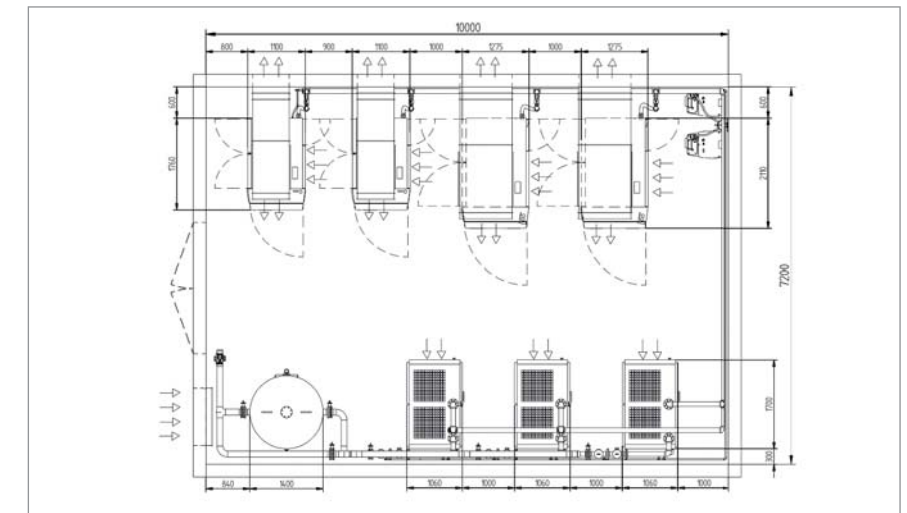

Fig. 2b: Layout diagram of a compressed air station

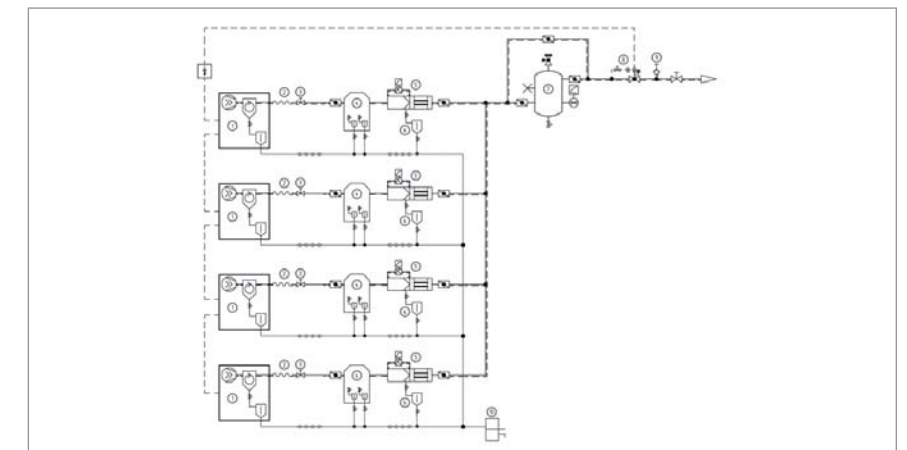

Fig. 2c: P+I diagram of a compressed air station

Efficient compressor station cooling

Compressors convert 100 percent of the electrical power consumed into heat. Even a relatively small 18.5 kW compressor easily generates enough surplus thermal energy to heat a typical family home. This is why efficient cooling is essential for reliable operation of a compressed air system.

The exhaust heat generated by compressors is a perfect source of reusable energy. With the help of appropriate heat recovery systems, up to 96% of the power consumed can be recovered as heat, and if this is put to good use it can significantly reduce the costs of compressed air production (see Chapter 8, pg. 20 f.). However, even where heat is recovered, the compressor still needs an effective cooling system. The costs for air cooling can be up to 30 percent lower than those for water-cooled systems. This is why air-cooled systems should be given preference wherever possible.

1. The compressor environment

1.1 Clean and cool is best

One of the main requirements of health and safety regulations is that compressors must be installed in such a way as to allow adequate accessibility and sufficient cooling. Regulations for the installation of compressors require that ambient temperatures for the operation of air and oil-cooled compressors may not exceed +40 °C.

Regulations also state that dangerous substances must never be released near compressor intake areas. These regulations stipulate just the minimum requirements. Their purpose is to keep the risk of accidents as low as possible. Efficient compressor operation with minimal maintenance requirement, however, demands a lot more.



Example of a compressed air station with exhaust air system and thermostatically controlled additional ventilation for the refrigeration dryers

1.2 The compressor room is not a storage area

A compressor room is not a storage area and should be kept free of dust and other contaminants, as well as extraneous equipment that has nothing to do with the production of compressed air; the floor should also be non-friable. Under no circumstances may air be drawn in to the compressor room from a dusty or otherwise contaminated environment unless intensive filtration is used. But, even under normal operating conditions, intake and cooling air should be cleaned with appropriate filters.

1.3 A suitable and constant temperature

Temperature has a considerable influence on the reliability and maintenance requirements of compressors; inlet and cooling air should be neither too cold (<+3 °C) nor too hot (>+40 °C). This must be taken into account in the planning and installation phases. For example, summer sun shining on south or west-facing walls of a building can

increase the room temperature considerably. Even in temperate climate zones room temperatures can reach over +40 °C. This is why apertures for cooling and inlet air should be located in shaded walls and not in direct sunlight. The size of the apertures is related to the capacity of the compressors installed and to the method of ventilation used.

2. Ventilating the compressor room

No matter whether using air- or water-cooled compressors, adequate compressor room ventilation is essential. Whatever the case, heat radiated within the compressor package from the airend and electric motor has to be extracted from the room. This corresponds to approximately 10 percent of compressor drive power.

3. Various methods of ventilation

3.1 Natural ventilation

Cooling air is drawn into the room by the compressor fan, the air is heated as it passes over the compressor and rises upwards, leaving the compressor room

through an aperture placed near the ceiling (Fig. 1). This kind of ventilation can only be recommended, however, for use in exceptional cases and for compressor powers below 5.5kW, since even sunshine or wind pressure on the exhaust aperture can cause problems.

3.2 Forced ventilation

This method uses a forced flow of cooling air. Ventilation is thermostatically controlled to prevent the temperature in the compressor room from falling below +3 °C during colder times of the year. Low temperatures negatively impact the performance of the compressors, the condensate drains and the air treatment equipment. Thermostatic control is necessary because with forced ventilation the compressor room is subjected to slight negative pressure that prevents back-flow of hot air into the room. There are two methods of forced ventilation:

3.2.1 Ventilation with an external extractor fan

A fan installed in the exhaust aperture of the compressor room and fitted with a thermostatic control (Fig. 2) exhausts the heated air. An important requirement for this type of ventilation is that the cooling air inlet aperture is of sufficient size (see lower right in the illustration); if it is too small, it could cause too high a vacuum resulting in increased noise from excessive air-flow speeds. In addition, cooling of the compressed air station would be endangered. The ventilation should be designed to restrict the temperature rise in the room caused by waste heat from the compressor to 7 K above inlet temperature. Otherwise heat will build up and cause a compressor breakdown.

3.2.2 Ducted ventilation

Modern, fully encapsulated rotary screw compressors provide an almost ideal way of ventilation by means of

exhaust ducting. The compressor fan draws in cooling air through an appropriately sized aperture and discharges it into a duct that takes it straight out of the compressor room (Fig. 3). The principal advantage of this method is that the temperature of the cooling air may be allowed to rise significantly higher, to approximately 20 K above ambient. This reduces the volume of cooling air needed. Normally, the cooling fans fitted in the packaged compressors have sufficient residual thrust to drive the cooling air through the ducting and out of the room. This means that in contrast to ventilation with an external extractor fan no additional energy is required. This applies only, however, if the residual thrust of the fans is sufficient for the ducting used. Ideally, the exhaust duct should be provided with a thermostatically controlled flap (Fig. 4) to direct hot air into the compressor room in winter to maintain proper operating temperatures. If air-cooled dryers are also installed in the compressor room then the compressor(s) and dryer(s) should not influence each other's ventilation air flows. At temperatures above + 25 °C it is recommended to increase the cooling air flow rate by running a supplementary thermostatically controlled fan in the ducting for the refrigeration dryers.

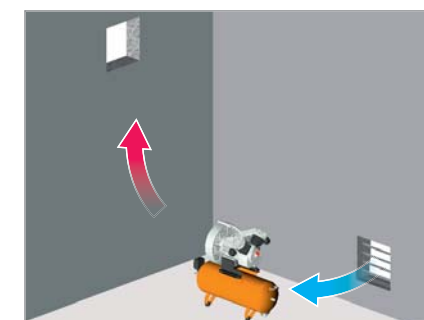

Fig. 1: Natural ventilation for compressors up to 5.5 kW



Fig. 2: Forced ventilation with extractor fan for compressors from 5.5 to 11 kW

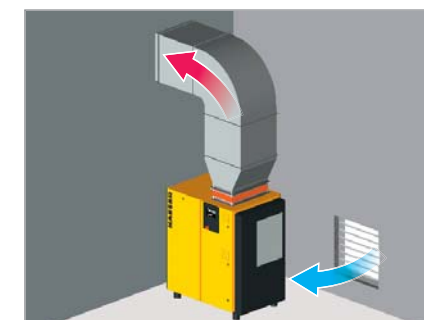

Fig. 3: Forced ventilation with exhaust ducting for machines above 11 kW

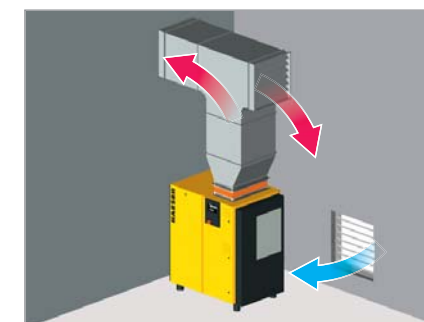

Fig. 4: A thermostatically-controlled flap directs warm air into the compressor room in winter

Ensuring long-term reliability and cost-optimisation

On pages 22 to 33 we covered aspects that had to be taken into account during installation and refurbishment of existing compressed air networks and how an efficient compressed air system should be planned and designed. Energy, cost-conscious planning and implementation, however, go only halfway. Efficient compressed air system operation also ensures cost-effective compressed air production over the long-term.

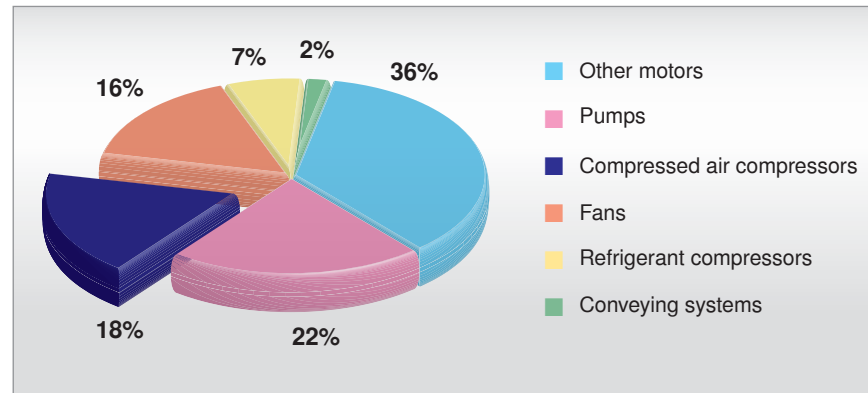

Fig. 1: Amount of energy consumption attributed to compressed air compressors in relation to the energy consumed by industrial electrical drives in the EU (Source: SAVE II (2000))

Maximum compressed air efficiency brings triple savings: air system reliability increases, whilst compressed air costs and power consumption significantly decrease. The efficiency potential is impressive to say the least: The EU "SAVE II" study showed the extent of the potential savings that can be achieved: Compressors in the EU consumed 80 billion kWh in 2000. At least 30 percent of this energy could be saved (Fig. 1).

1. What is "optimum efficiency"?

The efficiency of a compressed air system is reflected by its cost structure. The achievable optimum is never the same because it is related to a specific company and its production. Critical

factors are compressor operating life, working pressure and other commercial parameters.

The example illustrated is an optimised system with air-cooled compressors, operational life 5 years, power costs 8cent/kWh, interest rate 6%, 7bar working pressure, air quality to ISO 8573-1: Class 1 residual oil content, Class 1 remaining dust content, Class 4 remaining water content. The example shows that even under optimum conditions power consumption still takes up the lion's share of overall compressed air costs (around 70%) (Fig. 2). A University of Coburg study

in 2003 (Fig. 3, pg. 35) highlighted the inefficiencies of compressed air stations in use in Germany.

2. Maintaining efficiency

Anyone interested in long-term compressed air system efficiency should consider the following points carefully:

2.1 Demand-oriented maintenance

Advanced internal compressor controllers such as the SIGMA CONTROL, and compressed air management systems, such as the PC-based SIGMA AIR MANAGER 2, provide detailed service interval information for the components that comprise the compressed air station. This has made it possible to carry out preventive maintenance and demand-oriented service work. This results in lower maintenance costs, as well as increased efficiency and reliability.

2.2 Matching air-consuming equipment

It is only too easy to make 'savings' for compressed air production and consumption in the wrong places, e.g. to use a budget-priced production machine that requires a higher working pressure. The cost of generating pressure higher than the standard 6 bar, for example, would quickly rise above

the extra cost for a more efficient machine working with a lower pressure. Therefore, when considering the specification of new air-consuming production machines, the pressure of the air needed is just as important as the electrical power supply, which is why guidelines should be written for the purchase of such production machines that cover both electrical power and compressed air supplies.

2.3 New production-related requirements

2.3.1 Compressed air consumption

a) Changes to production

In most manufacturing facilities the compressed air demand varies from shift to shift. However, if not taken into consideration, changes to a production process may result in compressors operating far below capacity in one shift, yet in others not being able to cover demand – even with reserve capacity. The air supply should therefore be designed to accommodate any such changes.

b) Expansion in production

In this case not only the compressor capacity but also the pipe work and the air treatment equipment may have to be adapted to meet the increased demand. It is advisable to precisely measure and document the air consumption of the existing compressor system in order to gather enough detailed information to economically modify or expand the air supply system to produce the higher capacity needed.

2.3.2 Air supply reliability

It is usual to include a standby compressor in an air station to provide coverage when another is being serviced or replaced and to cater for occasional demand peaks. Such a reserve capacity, however, should be

Inefficiencies in compressed air stations and production areas

Compressed air station

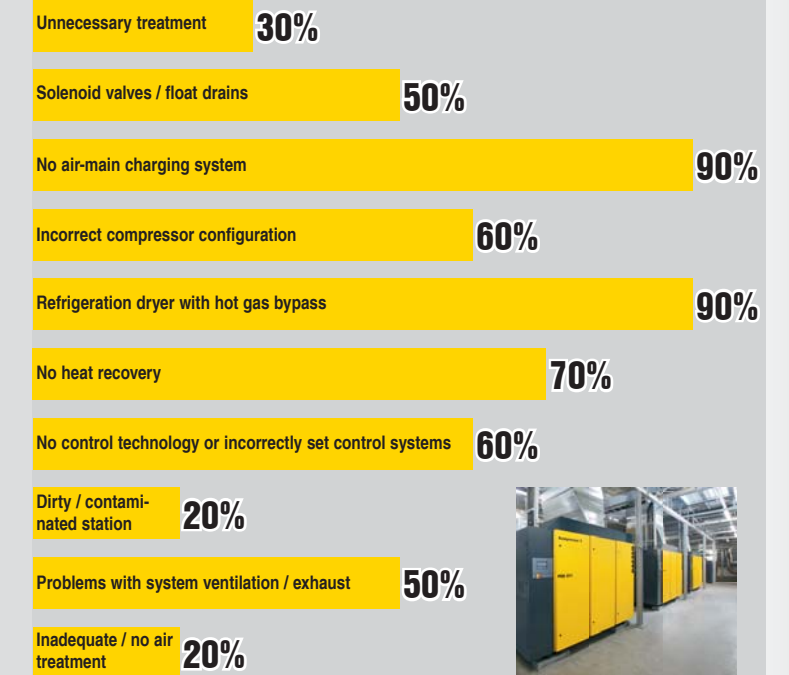

Production

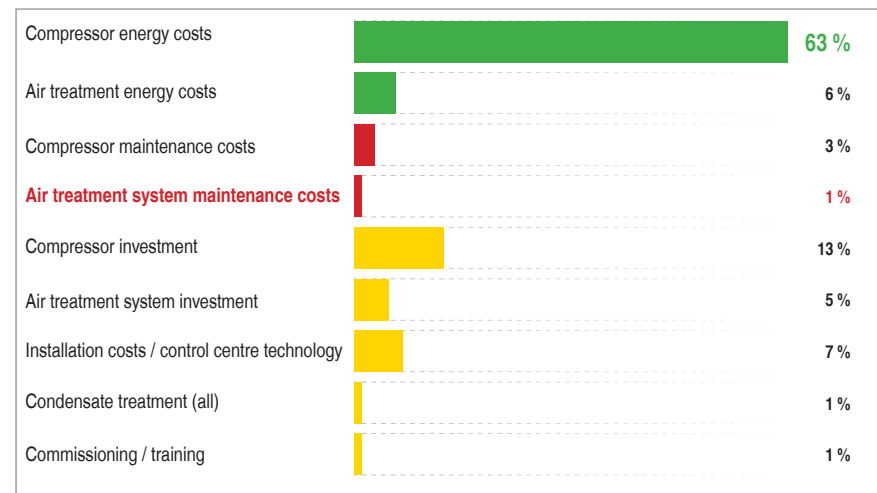
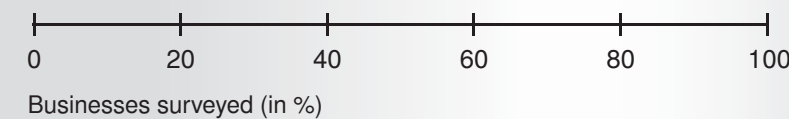
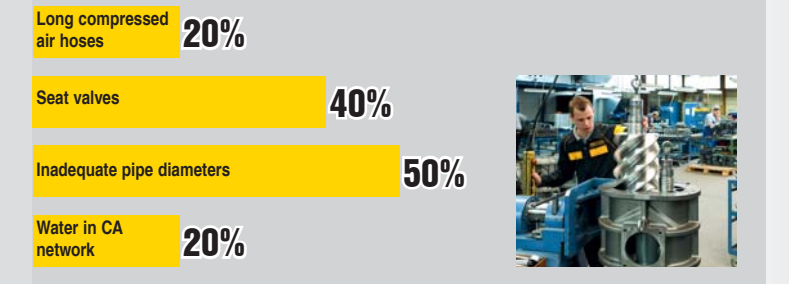

Fig. 2: The cost structure of an optimised compressed air system

Fig. 3: For original findings, please refer to the results analysis of the compressed air audits performed by KAESER KOMPRESOREN within the scope of the 'Drucklufteffizient' campaign. Thesis: Anja Seitz, Coburg University, Specialism: Mechanical Engineering (2003)

Ensuring long-term reliability and cost-optimisation

matched by reserve capacity in the air treatment equipment. When air consumption rises, the standby compressor cuts in, but because of the lack of additional air treatment capacity the compressed air quality deteriorates as a result. Therefore, a treatment unit (dryer/filter) should be provided for each standby compressor.

2.3.3 Changing of air quality

If higher air quality is needed the procedure differs depending on whether all areas of production are affected or only one specific area. In the former



Fig. 4: Leakage location using ultrasound

case, it is not enough to simply re-equip the central compressed air supply. The pipe work that has transported air of lower quality will have to be cleaned or renewed. In the latter case, local air treatment that can supply the quality required is recommended. Airflow through local treatment devices should be limited.

This ensures that an increase in demand above that for which the devices are intended does not result in degradation of air quality.

2.4 Monitoring leaks

Leakages occur in every compressed air distribution network and can lead to considerable energy losses. The

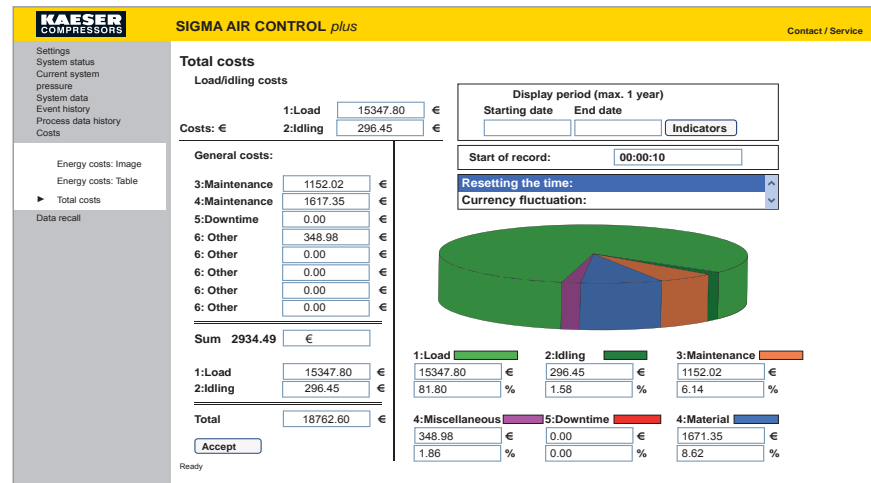

Fig. 5a: Management system: Compressed air cost analysis (web-based)

main cause is wear on tool, hose connections and machine components (Fig. 4). This is why it is vital to keep track of such problems and to take prompt action whenever they occur. It is advisable to regularly measure overall leakage with the aid of modern control and monitoring systems such as the SIGMA AIR MANAGER. If an increase is recorded, the leaks must be traced and eliminated.

3. Cost management ensures efficiency

Information gathered through analysis during the planning stage is also relevant for future system operation. Once the system is installed and running, however, no special analysis is needed to acquire data at a later stage. These tasks are taken over by advanced master controllers such as the SIGMA AIR MANAGER. This forms the basis for comprehensive compressed air audits and effective compressed air system cost-management (Fig. 5a to e). The more users introduce transparency into their air cost structure, search

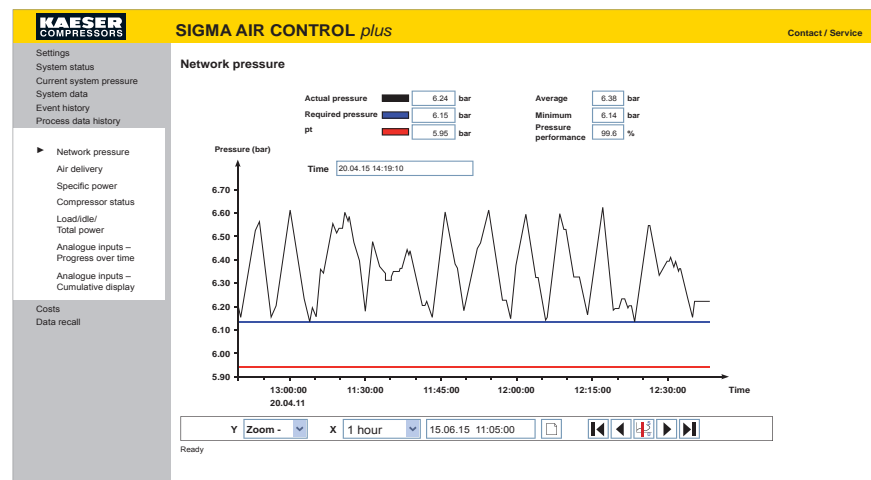

Fig. 5b: Pressure curve

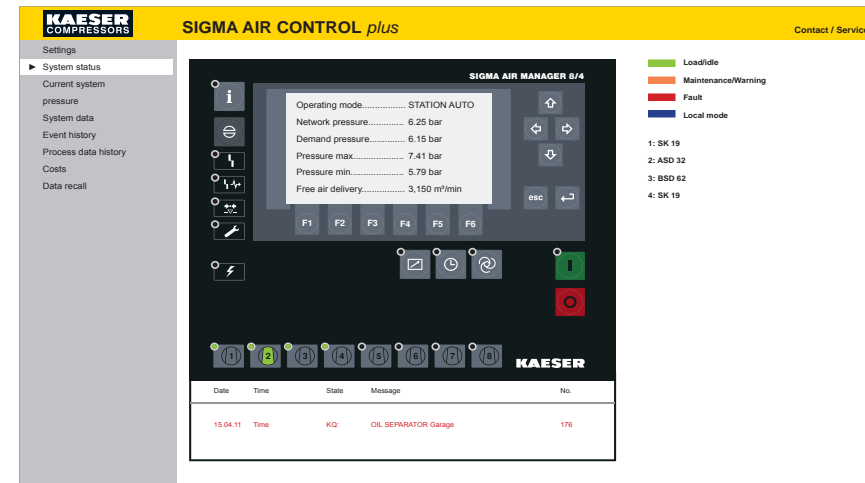

Fig. 5c: Overview: Control and management system

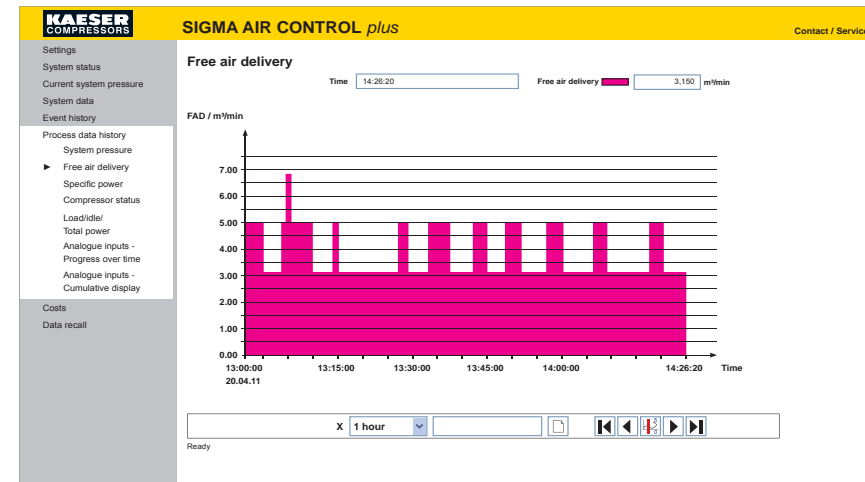

Fig. 5d: Compressed air consumption

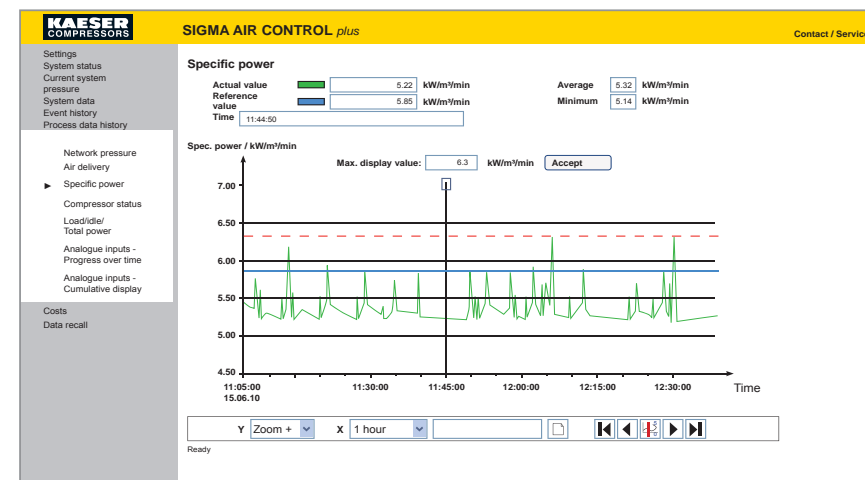

Fig. 5e: Specific power requirement

out potential savings and give priority to energy efficiency rather than price when purchasing air supply equipment, the nearer we will get to achieving the calculated 30 percent energy-saving potential. That's not only good for the balance sheet, but also benefits the environment.

Practical tips

Tips 1 - 7

40-51

Tip 1

Savings with optimised pressure

The efficiency of a compressed air system doesn't just depend on the correct working pressure. Even small measures can often have a large effect.

In many cases, the connection to the compressed air tools looks as follows: At rest, the pressure at the maintenance unit is 6.1 bar and 6.0 bar at the tool. However, this pressure is not the same as the pressure when air is being used.

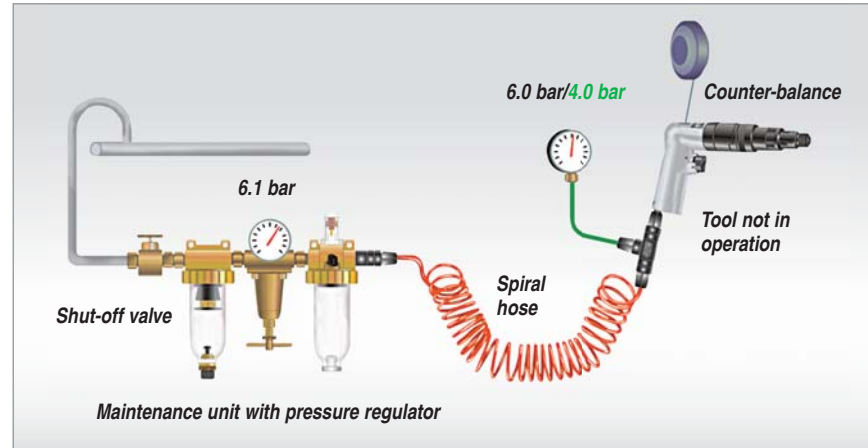

Caption: Tool connection with spiral hose – 6.0 bar pressure with zero compressed air consumption. 4.0 bar when tool in operation = 2 bar pressure drop when tool in operation: only 54% of full performance capacity!

Pressure drop at the tool – what to do?

Pressure measurement on a working tool often shows a considerable pressure drop. In the following example, this drop is 2 bar; in other words the tool delivers only 54% of its potential performance.

The **causes** for this can often be easily remedied:

a) Insufficient connection diameter: Use a quick-coupling with a larger flow passage.

b) Incorrectly adjusted pressure regulator: Open it further.

c) System pressure too low: Increase the pressure in the air-main or install pipework with a larger diameter.

d) Spiral hose is too small: Use a larger spiral hose or – preferably – a smooth hose.

e) Pressure drop in the decentralised water separator: Dry compressed air centrally (makes the separator superfluous). These are simple steps to restore optimal tool pressure (6 bar, in this case) and performance at 100% of capacity.

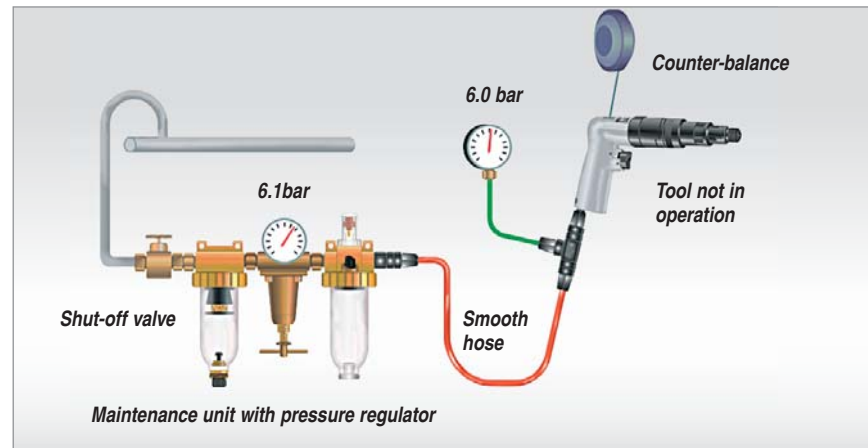

Water separators and spiral hoses are energy wasters: instead, dry compressed air centrally and use smooth hoses

Saving energy – with the right turn

Pressure regulators affect the efficiency of compressed air usage to a greater extent than is often realised. In this example, the compressed air system is operating between 8 and 10 bar. The pressures of 7.5 and 9.5 bar, respectively, at the take-off points are reduced to 6 bar by a pressure regulator. To save energy, the system pressure is reduced to between 6.8 and 7 bar. This means that a pressure of 6.1 bar is available at the network take-off points, but only 4 bar is available to the tools. This configuration has consequences: work takes longer, work results may be

defective due to insufficient tool pressure and the compressors run longer than necessary. On the other hand, the desired savings can be easily and painlessly achieved by not only reducing the system pressure, but also by using smooth hoses, removing superfluous water separators and further opening the pressure regulators on the air-consuming equipment.

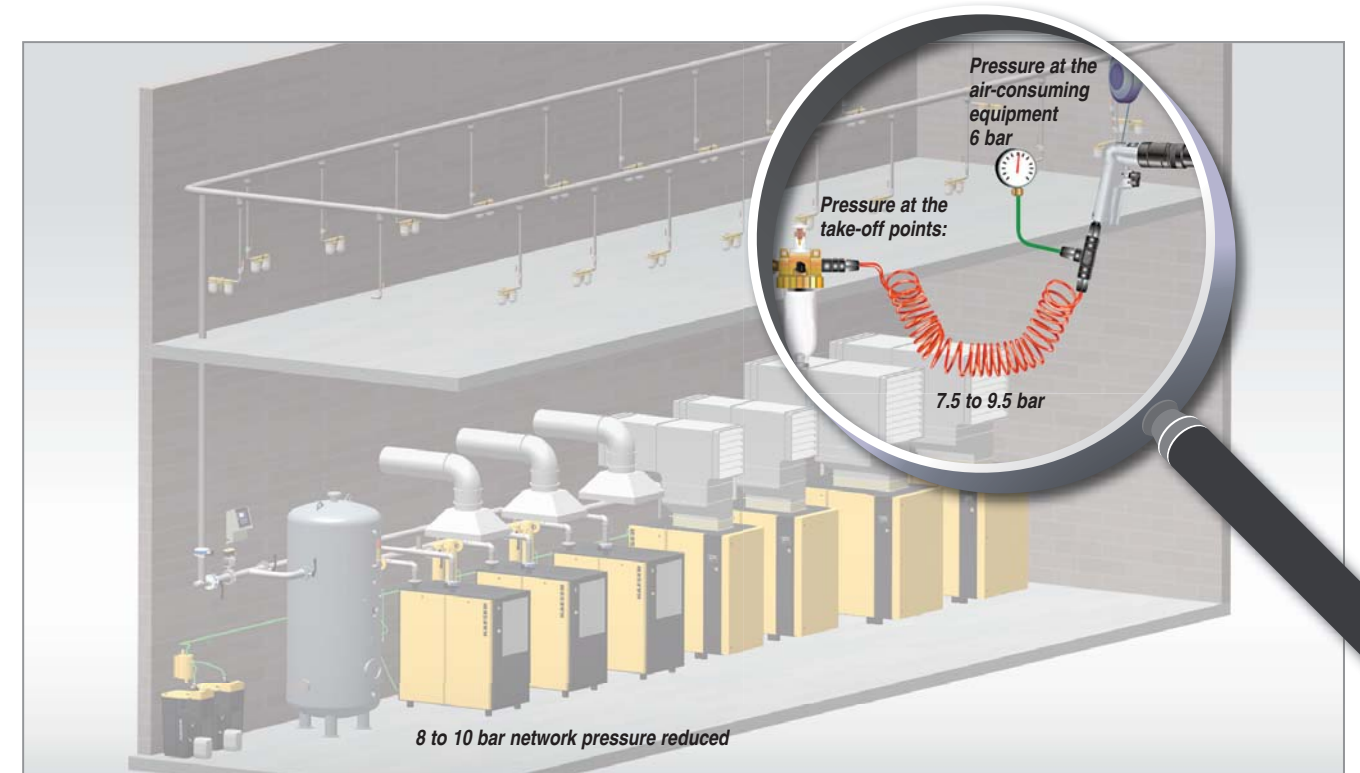

A waste of energy, pure and simple: higher compression than necessary, with pressure reductions at the air-consuming equipment...

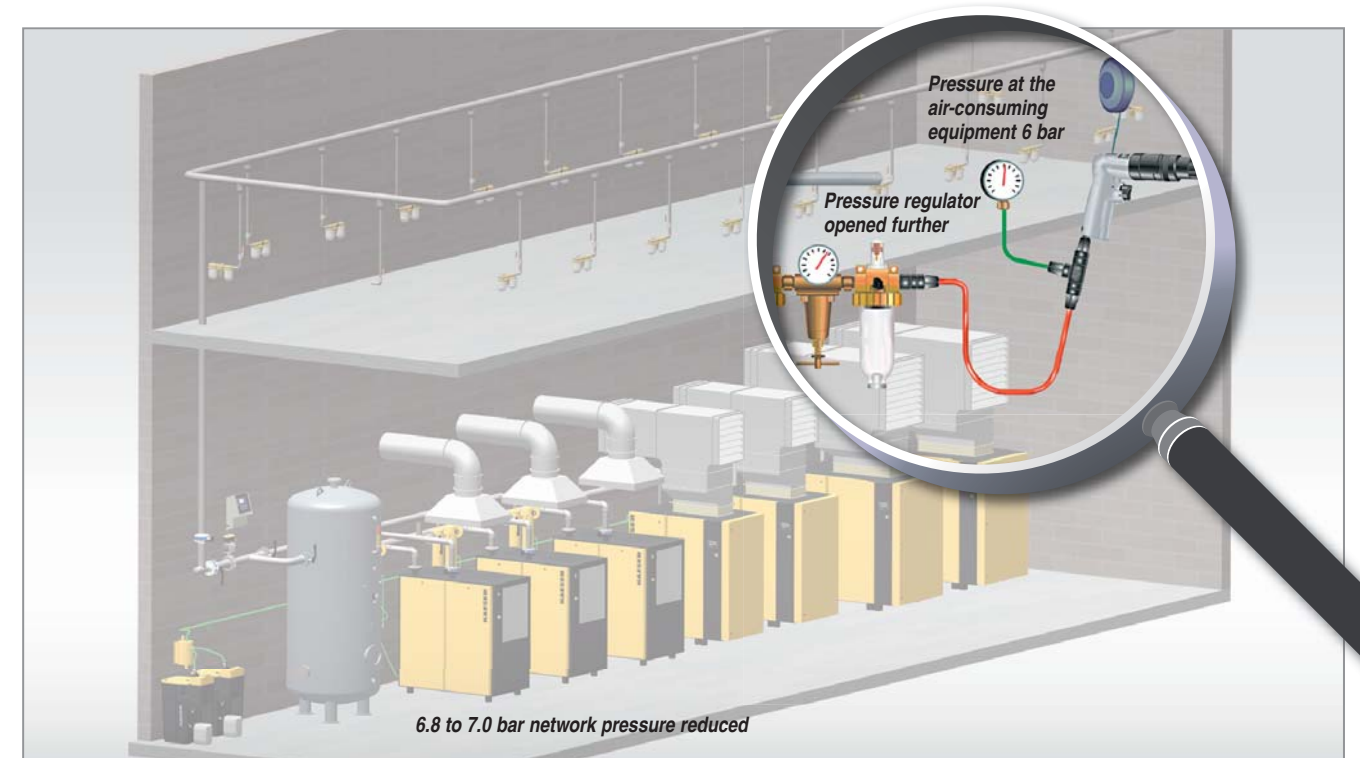

...instead, reduce system pressure and open the pressure regulator further

Tip 2

Correct pressure at the air connection

The compressor station pressure is actually correct, but pressure is too low at the air-consuming equipment. What's the cause?

In this case, hoses, quick couplings and pressure regulators are commonly the offending components. But often the pressure at the take-off point in the system is too low: for example, of the 6.8 to 7 bar originally available for the tools, a mere 5 bar remains.

Operators often turn to a quick fix: "Let's just set the station pressure 1 bar higher, who cares!" But this is problematic, because for every pressure increase of 1 bar, the energy consumption of the compressor station increases by 6% – and the leakage rate also sharply increases. It's therefore advisable to identify the causes and implement an appropriate solution.

Pipe network as the source of the problem

When the pressure directly downstream of the compressor is correct and there is no disproportionately large reduction due to downstream treatment compo-

ponents, the problem can only be in the pipe network. This is divided into three sections: the main line, distribution line and connection line (Fig. 1). In an optimised compressed air system, the following pressure drops are reasonable from an efficiency perspective:

Main line (1):	0.03 bar
Distribution line (2):	0.03 bar
Connection line (3):	0.04 bar
Additionally:	
Dryer (4):	0.2 bar
Maintain. unit/hose (5)	0.5 bar
Total:	0.8 bar

Eliminate 'bottlenecks'

Upon closer inspection, it often becomes apparent that although the main line and distribution lines have the correct dimensions, the connection lines are too narrow. For these, the pipe width should not be less than DN 25 (1"). For precise determination of the cross-section, KAESER KOMPRESSOREN offers a convenient on-line tool:

www.kaeser.com/Online_Services/Toolbox/Pressure_drop/.

Furthermore, a specialised **nomogram** can also be used; please see **Appendix 1, pg. 54 f.**

Ensure correct connections

To prevent disruptions and damage due to potential moisture, the connection between the distribution and connection lines should be designed as a flow-optimised "swan neck" (Fig. 2): a direct downward pipe should only be used if the possibility of condensate formation in the pipeline can be excluded with 100% certainty (Fig. 3).

The optimised connection, which has a maximum pressure drop of 1 bar between compressed air discharge at the compressor and the compressed air tool, is illustrated on **page 40**.

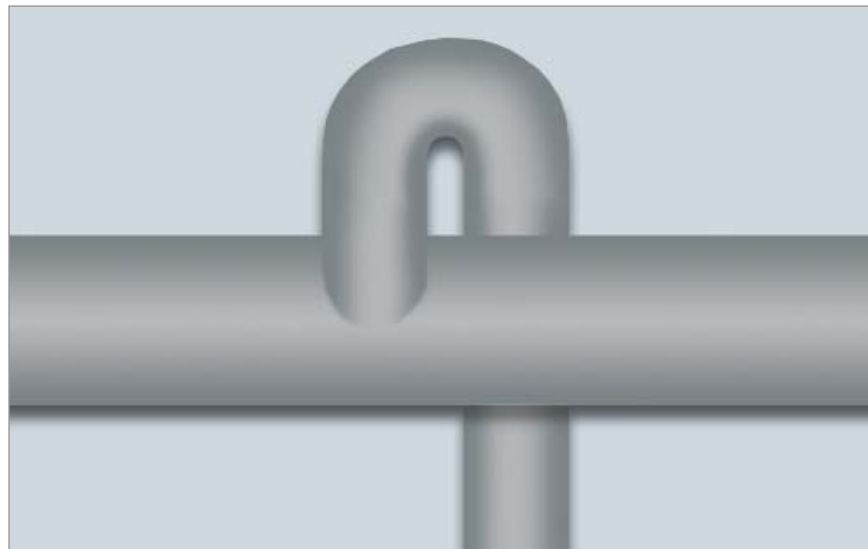

Fig. 2: Swan neck

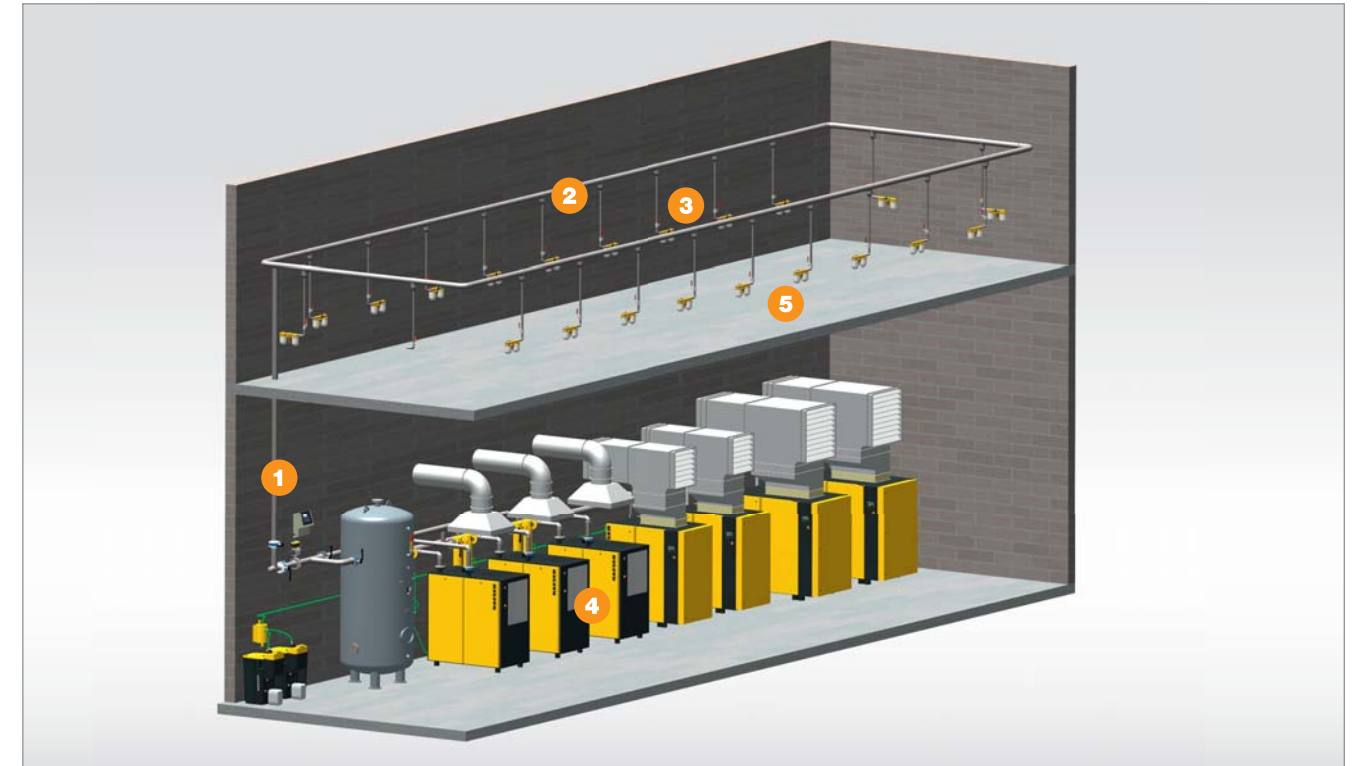

Fig. 1: Main components of a compressed air distribution system: Air-main (1), Distribution piping (2), Connection piping (3), Dryer (4), Maintenance unit/hose (5)

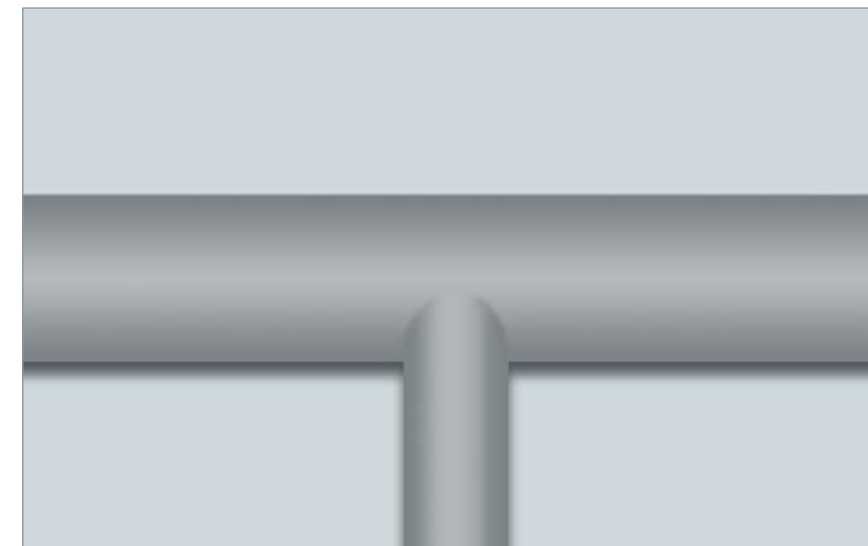

Fig. 3: Direct downward pipe

Tip 3

Efficient compressed air distribution

There are essentially three ways to distribute compressed air from the compressor system to the point of use: via branch line, ring main or distribution network. As to which system is most suitable depends on the company concerned. When looking at efficient use of compressed air, it is important not only to focus on energy-saving air production, but to also consider the most effective method of air distribution. Read on to find out how...

Branch line

Installation of a branch line with various outflow connections that lead to the individual air consumers (Fig. 1) is relatively straightforward. The length of piping required for the branch line is comparatively short, but must have sufficient capacity to meet the system's entire compressed air demand.

This means that the pipe diameter has to be significantly larger in comparison to ring main or distribution network piping. The connection lines to the air consumers also have to be larger, due to the increased distance from the main compressed air supply. In addition, this solution does not allow individual sections of the system to be shut-down in order to facilitate system expansion or cleaning work for example. Branch line systems are therefore best suited to small businesses.

Ring main

Installation of a ring main (Fig. 2) is more complex but has one considerable advantage over a branch line system: if using consumers each with the same compressed air demand, the connection pipe length and volume can be reduced by half. As a result, smaller diameter piping can be used and the capacity remains the same. The connection lines are very short and are seldom installed any larger than DN 25. Sufficient numbers of shut-off units should also be

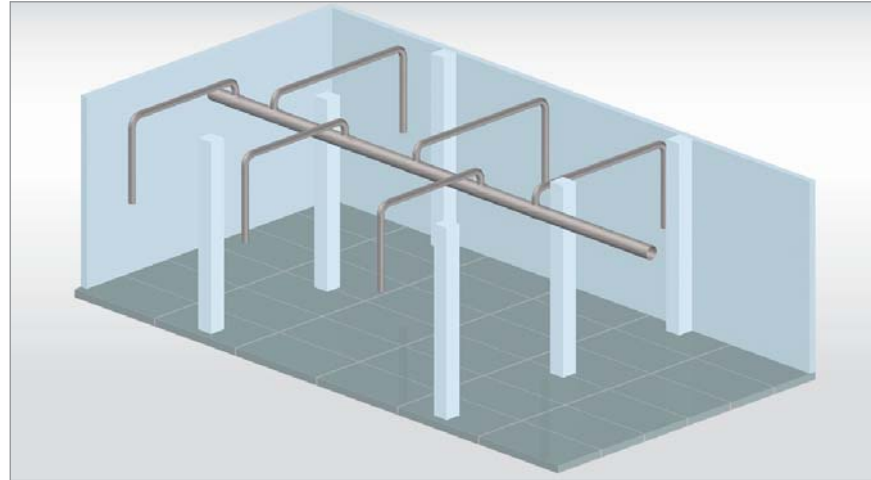

Fig. 1: Compressed air branch line

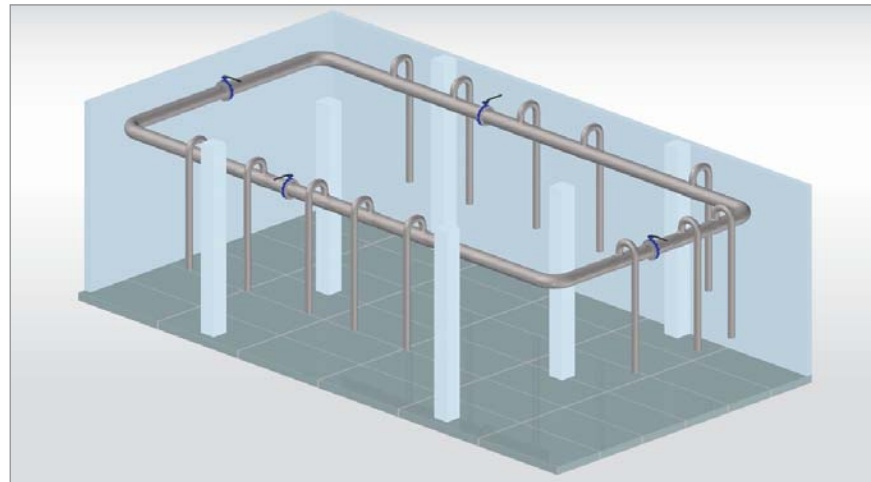

Fig. 2: Compressed air ring main

included in the ring main design, as this allows certain sections of piping to be taken out of operation for cleaning and system expansion purposes, leaving the rest of the air installation to operate as normal.

Distribution network

A distribution network is perfect for companies with large facilities. The design is very similar to a ring main, but includes additional longitudinal and cross connections that transform the system into a true pipe network (Fig. 3). Of course, this is the most complicated

system to install, but any additional effort is more than rewarded through the advantages that it brings. The network structure provides a reliable and energy-efficient supply of compressed air to large production halls with no need for excessively large pipe dimensions. On the contrary: pipe dimensions can be kept to a similar size as those in a ring main system installed in a small or medium sized business. The system has the further advantage that individual sections can be shut-down as required.

Designing the air-main

The function of a compressed air system's air-main is to connect the separate air distribution lines for various operational facilities (buildings) with the compressed air installation (generation).

The dimensions and capacity of an air-main are dictated by the total air delivery of the compressors within the compressed air system. Care should also be taken to ensure that the pressure drop does not exceed 0.03 bar.

Air from a single compressor package

If a single compressed air package supplies air to several operational facilities (e.g. production halls), then the feed lines, and therefore the air-mains for the individual areas, should be able to deliver the maximum volume of compressed air required by that area. Once again, the pressure drop should not exceed 0.03 bar. Pipelines bundled together in a collector within the compressed air station provide the advantage of being able to easily shut off entire work areas as required. Furthermore, with the addition of flow rate measuring equipment, the air consumption of individual areas can be easily determined (Fig. 4).

Air from multiple compressor packages

If several compressor packages supply the compressed air for a large air-main system, then the piping must have sufficient capacity to be able to deliver the maximum air volume from the largest compressor package of each production area. Again, the pressure drop between the individual packages should not exceed 0.03 bar, otherwise installation of complicated and expensive regulating systems becomes necessary (Fig. 5).

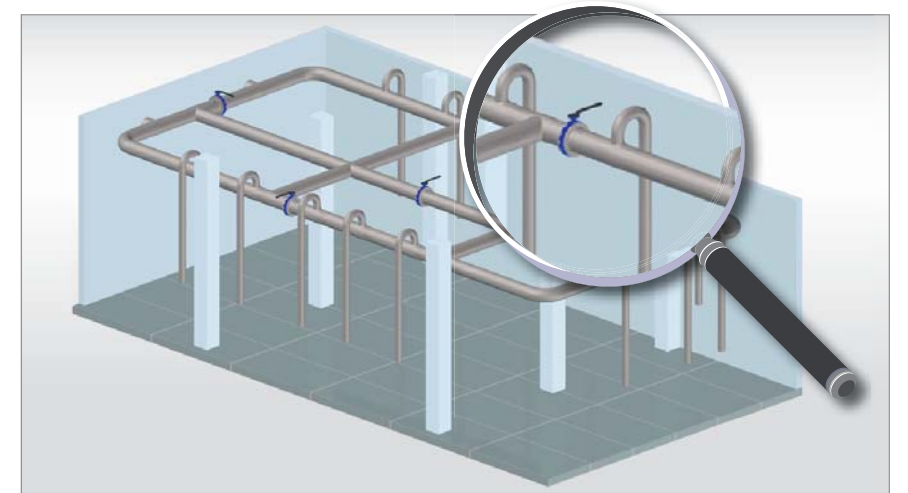

Fig. 3: Compressed air distribution network with pipeline grid

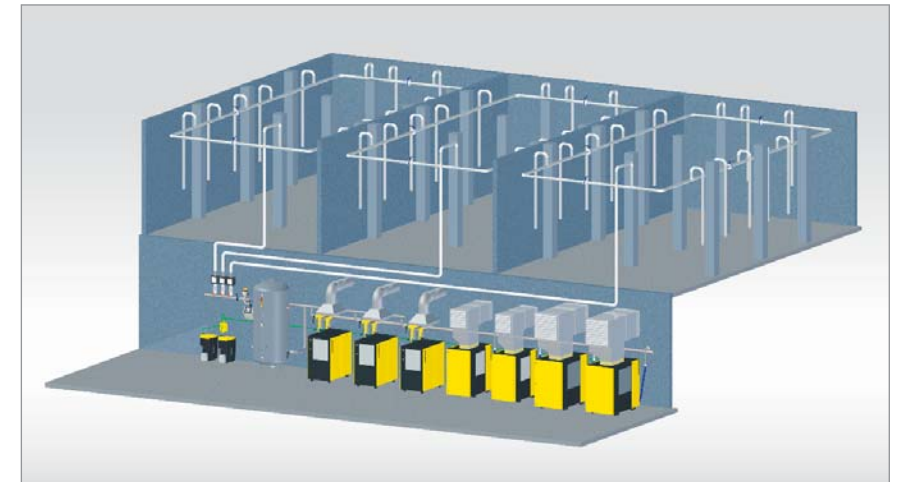

Fig. 4: Compressed air supply with a central compressed air station for multiple production areas

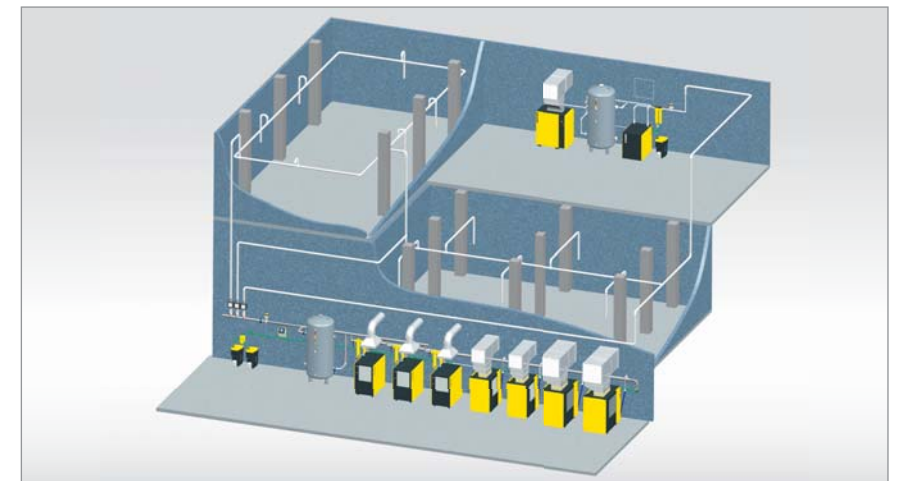

Fig. 5: Compressed air supply with two stations and central regulation for multiple production areas

Tip 4

Pipework in the compressed air station

The pipe network not only distributes compressed air within a company's facilities, but also connects the compressors and other components of the compressed air installation to the whole system. In order to ensure best possible efficiency and reliability, several important factors should be taken into consideration when installing the system.

The pipe network should usually be laid out in such away that the pressure loss caused by the piping remains below 0.01 bar at full flow capacity. It is also advisable to use only metal piping, as it can cope with differing thermal loads

Connection of compressed air distribution piping

The best way to connect the piping from the compressor station to the air distribution network is to use a collector. The collector acts as a central feed-off point for all distribution lines (Fig. 1.1) and, if necessary, allows the compressed air supply to be shut down for specific operating areas.

Installation in the 'moist air sector'

Installation of a condensate collector in the so-called 'moist air sector', i.e. the piping sections located downstream from the compressors and upstream from the air dryers, should be avoided if at all possible. Otherwise, the piping must slope towards the condensate collector, which must be drained via a specifically dedicated condensate drain (Fig. 2).

Correct component connection

The individual components of the compressor station (compressors, dryers etc.) should be connected to the main air line from above. Connection from the side is also possible with pipe diameters from DN 100 (Fig. 3 a/b).

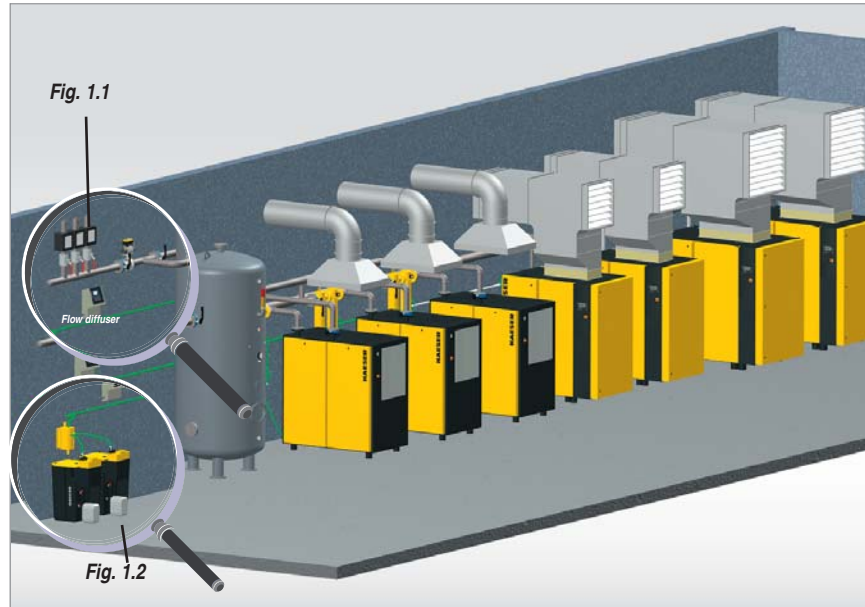

Fig. 1: Compressed air station with collector line

Compressor connection

Flexible connections should be used to connect the compressors to the air distribution network in order to avoid transmission of vibrations. Hose connections are suitable for pipe widths < DN 100 (Fig. 4). A vibration-absorbing fastening is attached between the hose and the first pipe bend to ensure that these forces are not transferred to the piping (Fig. 4.1). For pipe diameters > DN 100, axial compensators must be used instead of hoses (Fig. 3b) to implement the vibration-dampening connection between the compressor and pipeline system.

Correct condensate drainage

Reliable condensate removal is essential to ensure optimised compressed air system performance and availability. There are a few errors worth avoiding, particularly when it comes to installing compressed air lines. Despite today's advanced drainage technology, the connection lines used to connect these condensate treatment systems are often incorrectly installed. These prob-

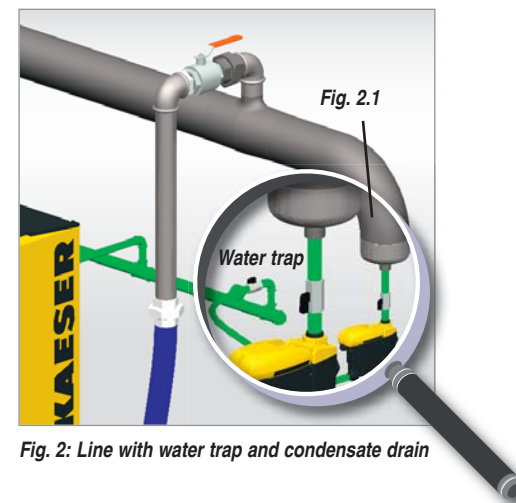

Fig. 2: Line with water trap and condensate drain

lems can be easily avoided however, by following the simple tips below:

Shut-off the condensate drain

Condensate drains should be able to be shut-off on either side via a ball valve so that they can be easily removed from the compressed air system should maintenance work need to be carried out (Fig. 2.1).

Correct connection size

The air-main collector should have at least a 1/2" connection in order to prevent unnecessary back-pressure.

Connection from above

The air-main collector should be connected to the condensate lines from above so that the drainage points do not influence one another (Fig. 3a (1)).

Sloping, pressure-free line

The condensate collector should always be installed at a gradient and should not be under pressure. Condensate drains from various system components (e.g. centrifugal separator, air receiver, refrigeration dryer, air filters) operating at different pressure levels should discharge only into a system like this. If this is not possible, then various connection points on the condensate treatment equipment (Aquamat) should be used.

Multiple treatment units

If, due to large volumes of condensate, it is necessary to use several treatment units, then the main condensate line should be connected via a flow distributor (Fig. 1.2).

System pressure above 15 bar

For systems with pressures above 15 bar, a separate high-pressure relief chamber should be used before the condensate is drained into the treatment unit.

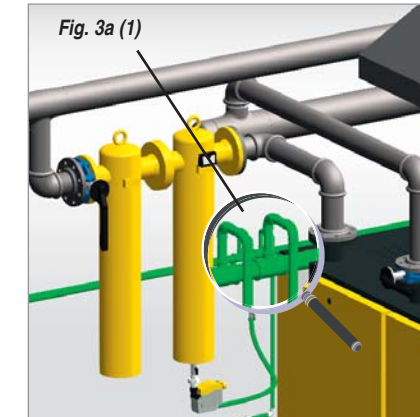

Fig. 3a: Connection of refrigeration dryer and condensate drain (from above)



Fig. 3b: Vibration-dampening compressor connection with axial compensators

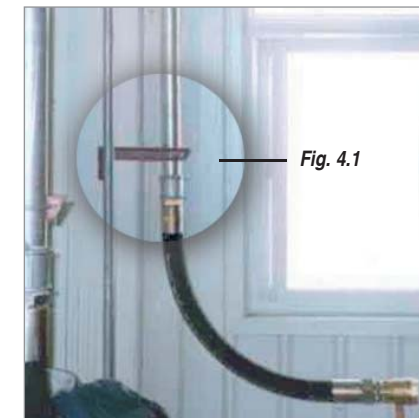

Fig. 4: Vibration-dampening compressor connection with a hose

Tip 5

Correct compressor installation

The installation location and the environmental surroundings of a compressed air system greatly influence compressed air production efficiency and reliability. Here are three rules worth remembering...

1. Keep the compressed air installation clean

The level of cleanliness for many compressed air systems leaves a lot to be desired, even if it doesn't look like the



Fig. 1: Neglected compressed air station

one shown in Fig. 1. Above all, cleanliness means protecting the equipment from exposure to dust. If care is not taken, the compressor intake filters will quickly clog up, which not only increases maintenance requirement and reduces performance, but also adversely affects air cooling. Subsequent consequences may include costly downtime due to overheating, decreased dryer power and, as a result, condensate accumulation. This in turn can cause serious damage to air-using equipment and can negatively impact product quality. Therefore, if dust exposure cannot be avoided by finding a dust-free installation location, then a bag filter should be used to clean the intake air (Fig. 2a, 2b).

2. Ensure moderate temperatures

Firstly, the compressed air system should not be exposed to sub-zero temperatures, as this leads to production and transport of moist compressed air before it reaches the air-using equipment; in the event of frost, the



Fig. 2a: Bag air filter (intake side)

condensate in the lines would freeze, resulting in operational disruptions. Secondly, the lubrication performance of the oils and bearing lubricants used in compressed air systems is significantly reduced at temperatures below + 5 °C. Needless to say, this can also lead to system failures. During the summer months however, as 100% of the electrical energy used to power the compressor is converted into heat, it is important to ensure – as far as possible – that the compressor room does not exceed the outside ambient temperature. Otherwise, motors and electrical components are liable to overheat and the dryer may become overloaded due to insufficient re-cooling. Once again, this leads to condensate accumulation and degraded performance of air-consuming equipment. In a worst-case scenario, insufficient ventilation can result in a build up of heat, which causes all compressor / dryer equip-



Fig. 2b: Bag air filter (compressor side)

ment to shut-down and the compressed air supply system to completely fail. All of these problems can be avoided simply by maintaining a moderate temperature in the compressor room. This can be guaranteed year-round via cooling systems, which automatically regulate the heat balance in the compressor station via thermostatically controlled ventilation (Fig. 3).

3. Maintenance-friendly station

Although modern compressors and treatment components require significantly less maintenance than older equipment, they are not completely maintenance-free. Therefore, the systems must be installed in such a way as to ensure easy, reliable access to all service-relevant areas. Optimum compressed air system reliability and performance can be achieved only if all three of these points are closely observed.



Fig. 3: Compressed air station with thermostatically-controlled air ducting

Tip 6

Compressed air station ventilation (intake)

Appropriate compressor system ventilation not only enhances compressed air availability, but also helps to minimise maintenance costs. Here's how it's done:

1. Correct location of ventilation openings

The location of ventilation openings is extremely important for effective ventilation of a compressor system. To ensure optimum system reliability, air that is drawn in from outside should be affected as little as possible by the weather. Therefore, it is advisable to install weather-protected ventilation openings in the lower half of the installation location's external wall, which – ideally – should not directly face the sun.

2. Protect the system from dust and contamination

The compressor system should be exposed to as little dust and contamination as possible. This includes all aggressive, or flammable, materials and emissions from combustion engines. Trucks and heavy vehicles in particular should not be allowed to enter the compressor system's air intake zone. If high levels of dust or contamination are unavoidable, then appropriate protection measures should always be taken. Moderate levels of dust and contamination can be alleviated using cooling air filters. In extreme cases, so-called 'dust traps' can be used.

3. Correctly size and equip the ventilation openings

The size of the ventilation openings depends on the power of the air-cooled compressors that are installed. As a rule of thumb, the 'free diameter' of the ventilation opening should be between 0.02 and 0.03 m² for every kilowatt of a compressor's rated power. This is equivalent to a cooling air volume of 130 to 230 m³/h.

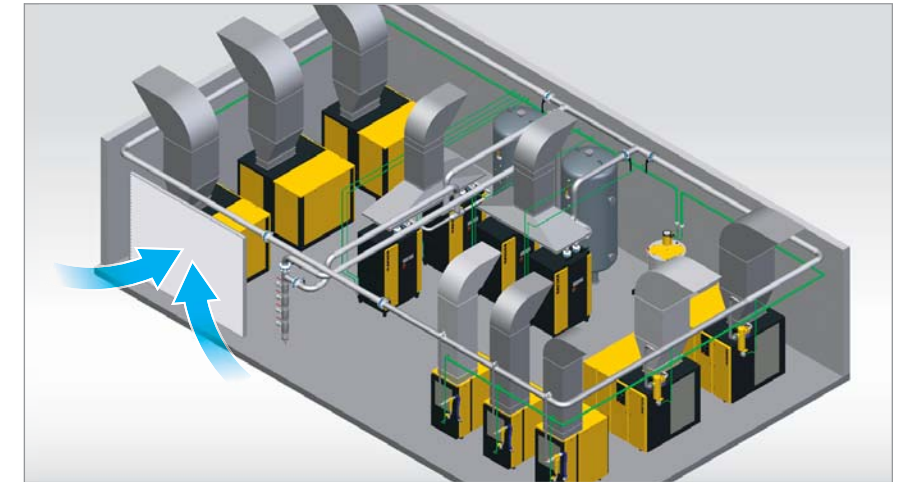

Fig. 2: Compressed air station with supply air system

It is important to take note of the term 'free diameter'. Weather protection screens, louvres and – in dusty environments – filters all considerably reduce the diameter of the ventilation opening: Depending on the quality of the selected ventilation system, the diameter is reduced by between 30 and 60 percent. It is therefore best to use flow-optimised ventilation systems. Whatever the case, compensation should always be made for reductions in diameter caused by protection and control devices.

A ventilation system generally comprises (Fig. 1) a bird protection screen, a weather protection screen, a (motor operated) flow adjustment flap and, if necessary, ventilation filters. For compressed air systems comprising several compressors, it is advisable to install a thermostatically controlled ventilation system and to divide the openings according to the position and power of the individual units (Fig. 2).

4. Also ventilate water-cooled compressors

Water-cooled compressors also require adequate ventilation, as they are usually powered by air-cooled motors, which radiate heat. Approximately 20 percent of a water-cooled compressor's power is converted to heat, which needs to be removed by the cooling air. Appropriately dimensioned ventilation openings should therefore be installed accordingly.

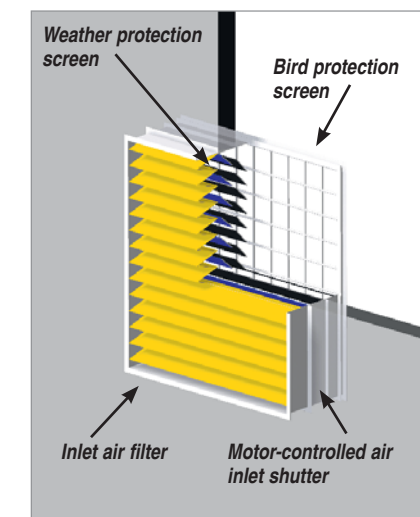

Fig. 1: Supply air system (design)

Tip 7

Compressed air station ventilation (exhaust)

In order to safeguard compressed air availability and keep maintenance costs to a minimum, compressed air stations must be equipped with appropriate exhaust ventilation. If the ambient temperature falls to below + 5 °C, then recirculated air should be used to keep the installation room at an appropriate temperature for compressed air system operation.

1. Manage exhaust air

Air exhaust ducts perform an important role in compressor installations: They remove the warmed cooling air, as well as the exhaust heat from the motor and the heat radiated by the compressors (Fig. 1). With modern machines, the exhaust heat from these various sources leaves the unit via a single air discharge opening (Fig. 1, circle). This must be flexibly connected to the air exhaust ducting via a canvas neck connection (Fig. 2). For ambient temperatures above + 10 °C, all of the air warmed with exhaust heat is removed from the compressor installation room. As older compressors often have separate air discharge openings, it may therefore be necessary to install individual ducting accordingly.



Fig. 2: Compressor ventilation connection with canvas duct joint

2. Install collective ducting

If installation of individual exhaust air ducting is not possible, then a collective exhaust air discharge duct (Fig. 3) must be provided. Check lou-

vres are necessary to properly connect the compressors. When closed, they prevent warm air from flowing back into the station when the given compressor is not in operation. Motor-actuated louvre flaps reduce pressure loss and can be activated in conjunction with the "Motor running" signal. Baffles should be installed to minimize pressure losses in the collective exhaust air discharge duct.

3. Use recirculated air to maintain the temperature in the installation room

Air recirculation flaps should be installed in areas where temperatures fall to below + 5 °C. These should be active from + 10 °C, whereby they open to a greater or lesser extent according to the temperature (Fig. 1). If the compressor system is completely shut down every once in a while, then a supplementary heating system should be used to ensure that the temperature in the installation room remains above + 5 °C.

4. Ventilate refrigeration dryers

Refrigeration dryers generate approximately four times as much heat energy than they consume as electrical energy. They should therefore have their own exhaust system equipped with a thermostatically controlled fan (Figs. 1 and 3). If the compressor installation includes several refrigeration dryers, then the fan should have a pacing control system that is activated from + 20 °C. As this exhaust system isn't in continuous operation, the ducting doesn't need to be installed directly on the dryer.

5. Correctly design and manage exhaust systems

All exhaust systems should be designed to ensure that any pressure drop they induce is smaller than the residual thrust delivered by the smallest machine in

the system (take note of manufacturer's specifications). Otherwise, exhaust air from this unit would flow back into the installation room. Additional fans are needed if there is insufficient residual thrust. The louvres should be automatically controlled via room thermostats and compressors. Monitoring with a master control system (e.g. SIGMA AIR MANAGER) is also recommended in order to be able to quickly identify potential problems with the louvres and to forward any alarm messages to a centralised control system.

6. Special cases – Water cooling

As water-cooled compressors emit the equivalent of 20% of their input power as radiant heat, these systems also require sufficient ventilation.

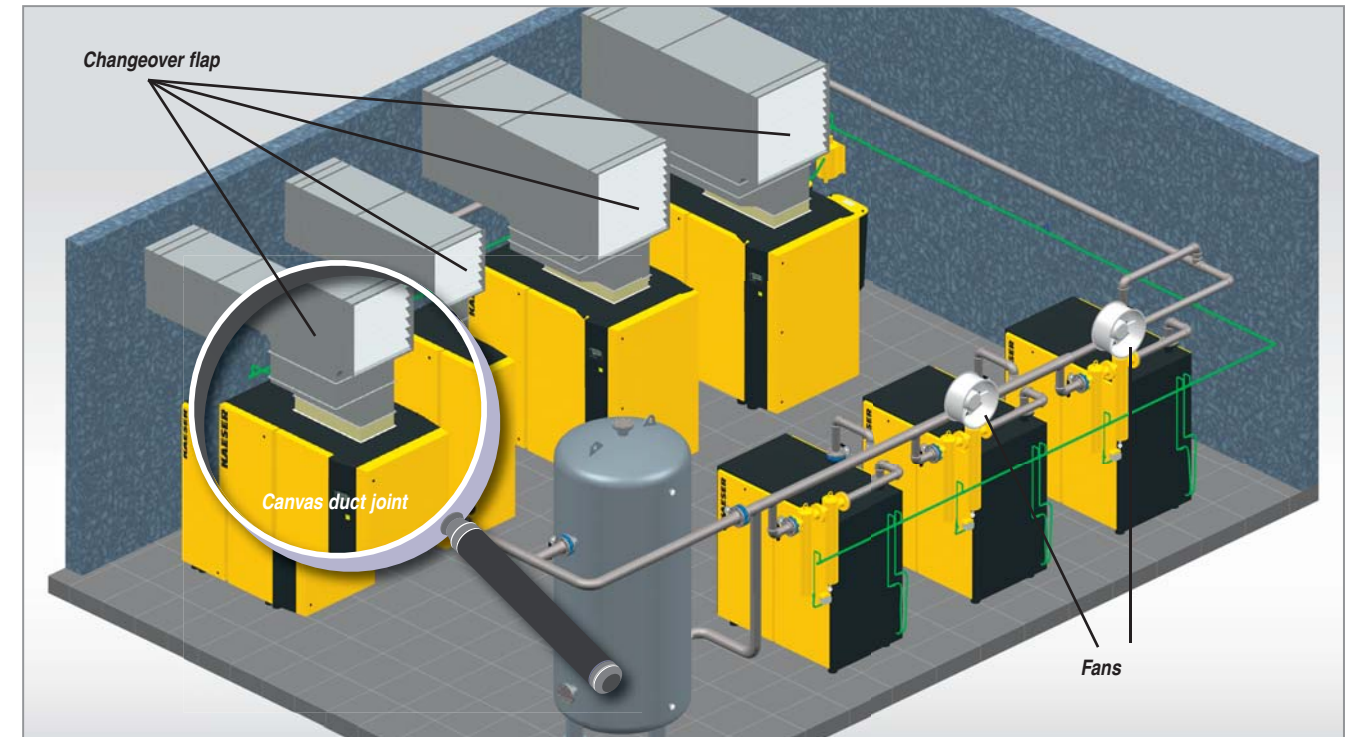

Fig. 1: Exhaust air system with individual ducting for each compressor

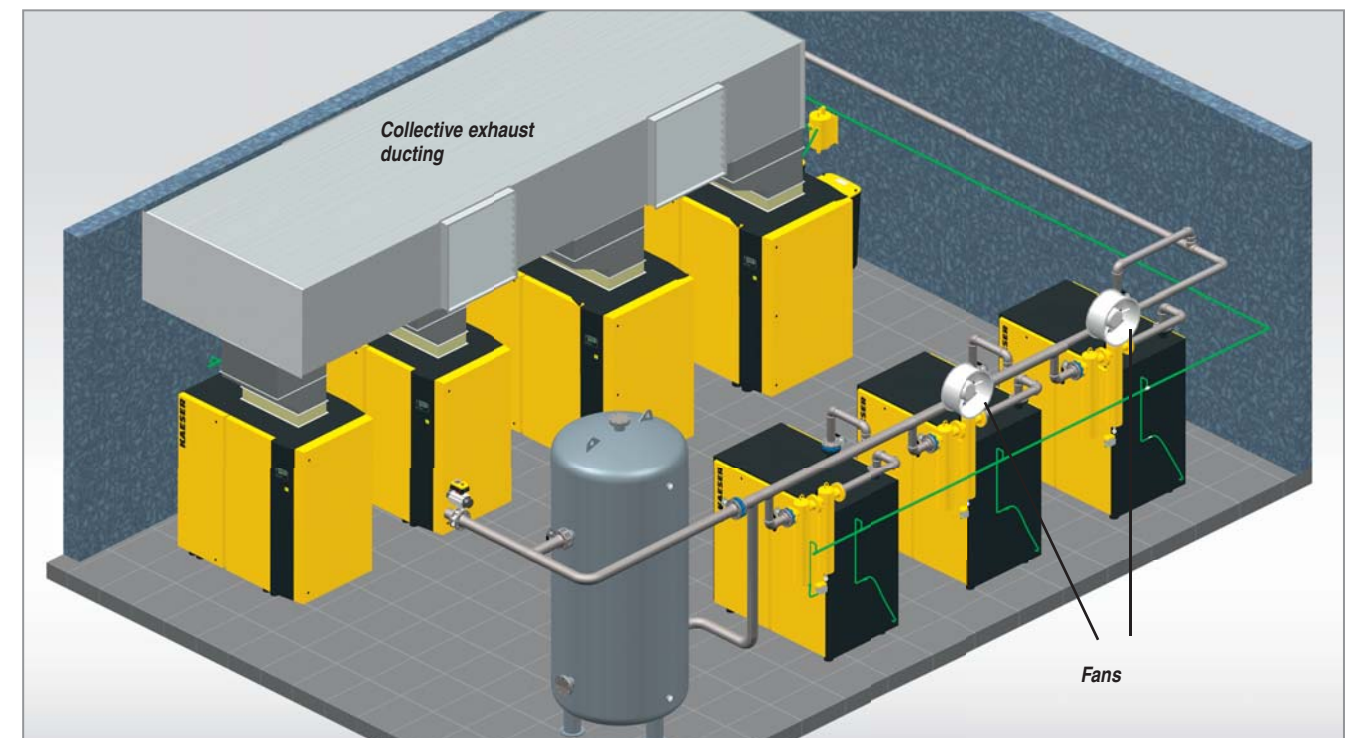

Fig. 3: Exhaust air system with collective exhaust ducting for all compressors

Appendices

Appendices 1 - 2

54-57

Nomogram to determine required internal pipe diameter

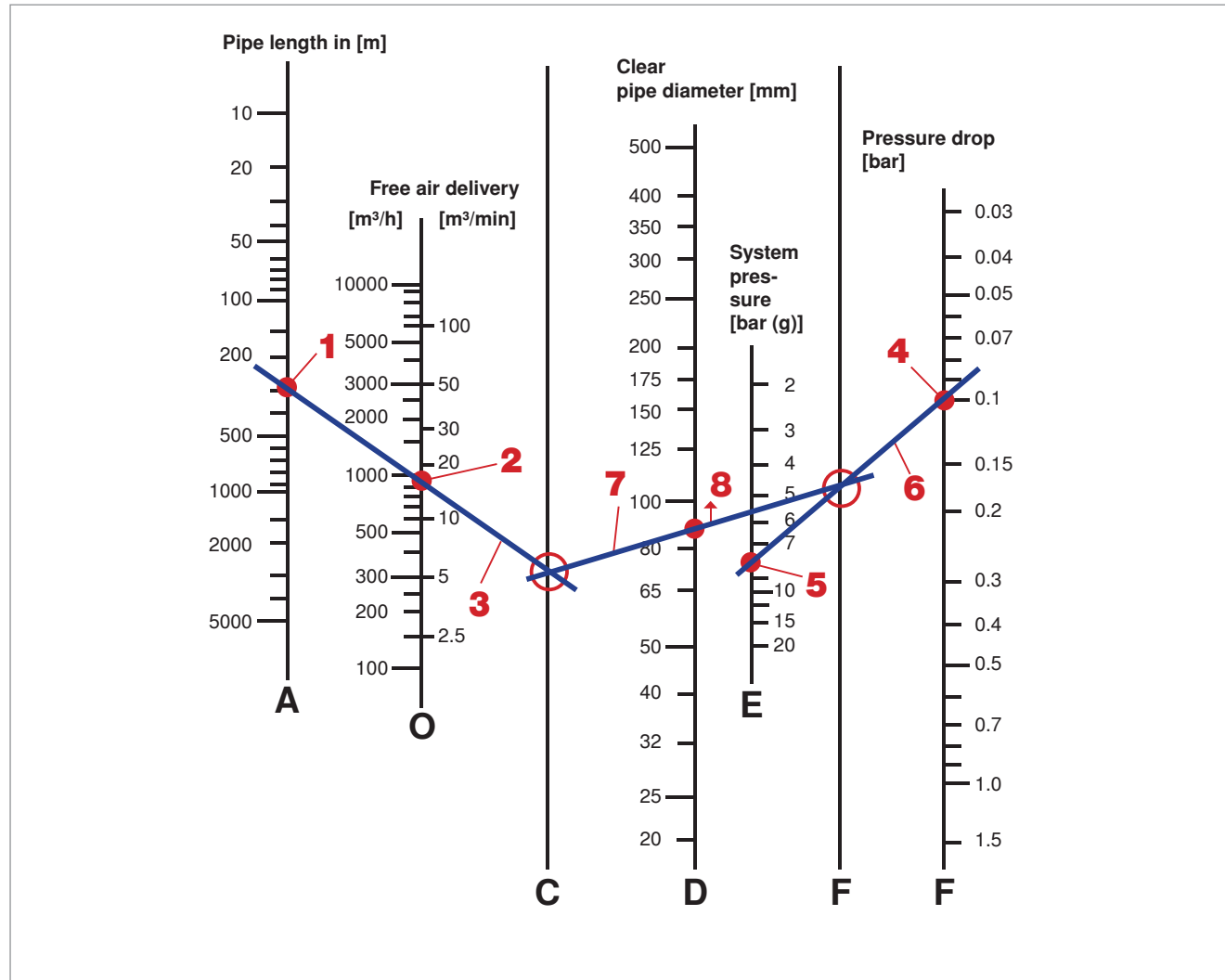

The required internal pipe diameter for compressed air lines can be calculated using this nomogram: Mark the A- and B-axes according to the pipe length and the delivery volume. Draw a straight line between both points, extending it to intersect

the C-axis. Finally, mark the minimum system pressure and the desired maximum pressure loss on the E- and G-axes. The straight line between these two points intersects the F-axis. By connecting both intersection points on the C- and F-axes with a straight line, you

attain an intersection point on the D-axis showing the required pipe diameter.

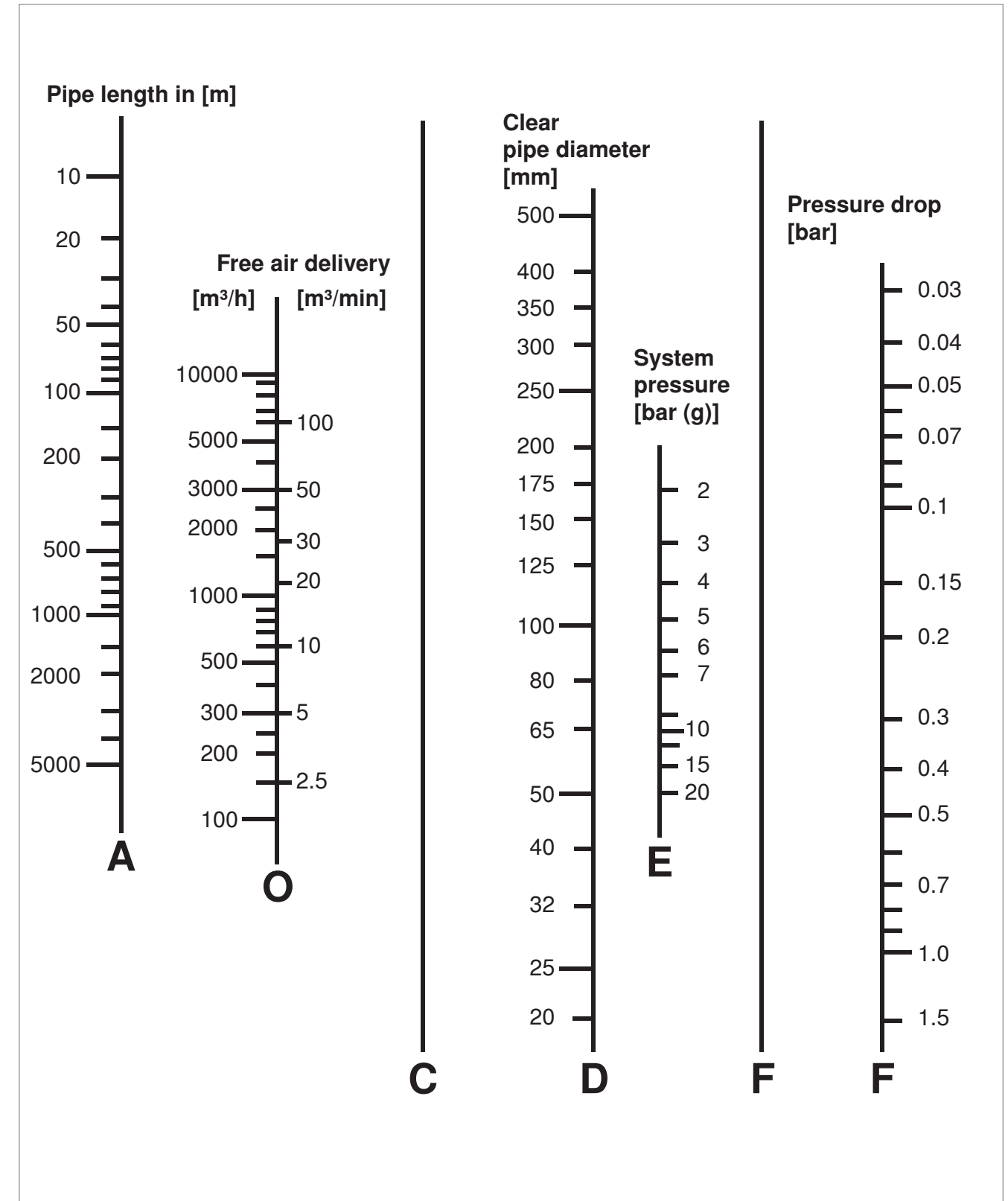

Questionnaire examples regarding the Energy Saving System Service

Energy Saving System Service



1. What free air delivery do the compressors need to provide?

1.1 Air consumption of tools and machines used

Tools, machines	Air consumption per tool, machine m ³ /min	No. of tools, machines	Load / duty cycle %	Simultaneity factor %	Actual calculated air consumption m ³ /min
	x	x	x	x	=
	x	x	x	x	=
	x	x	x	x	=
	x	x	x	x	=
	x	x	x	x	=
	x	x	x	x	=

Air consumption of all tools = V_{Tools} m³/min

1.2 Other consumers V_{Other} m³/min

1.3 Compressed air network leakages V_{Leakage} m³/min

1.4 Reserve V_{Reserve} m³/min

Min. req'd free air delivery from the compressors = V_{Total} m³/min

Energy Saving System Service



2. Are compressors already in use?

- No
- Yes

Operator's designation	Manufacturer	Model	Pressure bar _(g)	Free air delivery m ³ /min	Continued use planned? Yes No
				<input type="text"/>	<input type="checkbox"/> <input type="checkbox"/>
				<input type="text"/>	<input type="checkbox"/> <input type="checkbox"/>
				<input type="text"/>	<input type="checkbox"/> <input type="checkbox"/>
				<input type="text"/>	<input type="checkbox"/> <input type="checkbox"/>
				<input type="text"/>	<input type="checkbox"/> <input type="checkbox"/>
				<input type="text"/>	<input type="checkbox"/> <input type="checkbox"/>

Total free air delivery of existing compressors that will continue to be used

= V_{Existing} m³/min

Existing compressed air treatment components:

Type/model (dryer, filter, drain etc.)	Manufacturer	Designed for m ³ /min	bar(g)	Remarks e.g. Incorrectly sized



CSD 105

SIGMA 

IE3

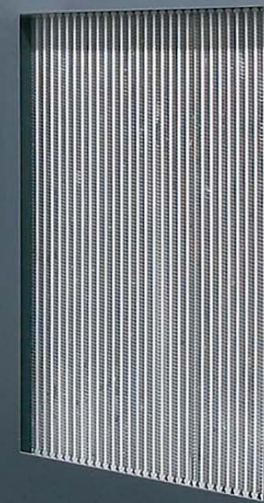

KAESER – The world is our home

As one of the world's largest manufacturers of rotary screw compressors, KAESER KOMPRESSOREN is represented throughout the world by a comprehensive network of branches, subsidiary companies and authorised partners in over 100 countries.

With innovative products and services, KAESER KOMPRESSOREN's experienced consultants and engineers help customers to enhance their competitive edge by working in close partnership to develop progressive system concepts that continuously push the boundaries of performance and compressed air efficiency. Moreover, the decades of knowledge and expertise from this industry-leading system provider are made available to each and every customer via the Kaeser group's global computer network.

These advantages, coupled with KAESER's worldwide service organisation, ensure that all products operate at the peak of their performance at all times and provide maximum availability.



KAESER COMPRESSORS Australia Pty. Ltd.

Locked Bag 1406 – Dandenong South – Vic. 3164

45 Zenith Road – Dandenong – Vic. 3175

Phone: +61 3 9791 5999 – Fax: +61 3 9791 5733 – E-mail: info.australia@kaeser.com – www.kaeser.com